

Alpine
By
**Comfort
Bilt**

*Building Quality
Comforts*



OWNER'S MANUAL

HP42 PELLET STOVE

⚠ WARNING!

Please read this entire manual before installation and use of this fuel-burning pellet room heater, and save for future reference. Failure to follow these instructions could result in property damage, bodily injury, or even death. Contact local building or fire officials about restrictions and installation inspection requirements in your area.



Safety Alert Key: It is important to pay attention to alerts you will see throughout this manual to ensure your safety.

- **DANGER!** Indicates a hazardous situation which, if not avoided, will result in death or serious injury.
- **WARNING!** Indicates a hazardous situation which, if not avoided, could result in death or serious injury.
- **CAUTION!** Indicates a hazardous situation which, if not avoided, could result in minor or moderate injury.
- **NOTICE:** Indicates practices which may cause damage to the stove or to property.
- **Pro Tip:** Indicates additional information to help you better understand your stove and optimize its performance.

This wood heater needs periodic inspection and repair for proper operation.

It is against federal regulations to operate this wood heater in a manner inconsistent with operating instructions in this manual.

NOTICE: FIRE RISK

SMG Hearth and Home / ComfortBilt disclaims any responsibility, and the warranty and agency listing will be voided by the below actions.



DO NOT:

- Install or operate damaged stove.
- Modify Stove.
- Install other than as instructed by the manufacturer.
- Operate the stove without fully assembling all components.
- Over Fire (burning at higher temperatures than recommended, causing permanent damage to the stove.)
- Install any components not approved by the manufacturer.
- Install parts or components not listed or approved.
- Disable safety switches.

⚠️ DANGER! HOT SURFACES

Glass and other surfaces are hot during operation and cool down.

Hot glass will cause burns.



- Do not touch glass until it is cooled.
- NEVER allow children to touch glass or door.
- Keep children away; if you expect that children may come into contact with the stove, we recommend a barrier such as a decorative screen.
- CAREFULLY SUPERVISE children in the same room as the stove.
- Alert children and adults to hazards of high temperatures.

High temperatures may ignite clothing or other flammable materials.

- Keep clothing, furniture, draperies, and other flammable materials away.

⚠️ WARNING!

This product, and the fuels used to operate is (wood), and the products of combustion of such fuels, can expose you to chemicals including carbon black, which is known to the State of California to cause cancer, and carbon monoxide, which is known to the State of California to cause birth defects and other reproductive harm.

For more information go to www.P65warnings.ca.gov



⚠ CAUTION!

- **Contact your local authority (Municipal building department, Fire department, Fire prevention bureau, etc.) to determine the need for a permit.**
- This stove should NOT be used as the **only** source of heat in the home. Power outages and periodic maintenance will result in a total loss of heat.
- Contact local building or fire officials regarding restrictions and installation inspection requirements for your area.
- Keep combustible materials (such as grass, leaves, etc.) at least 3 feet away from the flue outlet on the outside of the building.
- Installation and repair of this pellet stove should be done by a qualified service person. The appliance should be inspected before use, and at least annually by a qualified service person. It is imperative that the control compartments, fire box, and circulating air passageways of the stove be kept clean.



⚠ CAUTION!

Install at least one smoke detector on each floor of your home to ensure your safety. They should be located away from the stove, and close to the sleeping areas.
You should have separate CO monitors for areas near the stove

NOTICE!

- During a power outage, the stove will shut down safely. Do not open the main door or ash pan door. During a power failure, the exhaust fan will not run. Keeping the doors sealed will allow the exhaust vent to draft out naturally. When the power is restored, the stove will not restart. If the exhaust temperature is still 126° F (52° C) when power is restored, the exhaust and convection fans will continue to run until the stove cools.
- *Over Fire Protection:* If the stove is being over fired or burning too hot, the high limit switches will automatically shut down the stove to avoid damage to other components. If the temperature on the hopper reaches 197° F (92° C), the auger will automatically stop and the stove will shut down. The exhaust fan will continue to run until the proof of fire switch cools. Allow the stove to cool before attempting to re-ignite.



⚠ WARNING!

- If the electrical power fails at any time when the stove is hot, keep all stove doors closed. This will limit the amount of smoke in the space.
- Never shut the stove down (while running) by unplugging it from the power source.
- Never shut the stove down (while running) by switching off the main power switch on the rear of the stove.

This stove has a manufacturer set minimum low burn rate that must not be altered. It is against federal regulations to alter this setting or otherwise operate this stove in a manner inconsistent with the operating instructions within this manual. If the unit is modified, it will no longer be compliant with the EPA regulations.



Welcome, to the ComfortBilt Family!

Dear Valued Customer,

Warm greetings from the entire ComfortBilt team! We are absolutely thrilled to extend our heartfelt welcome and express our utmost gratitude for choosing us as your trusted provider. Your decision to join our family of satisfied customers means the world to us, and we are committed to ensuring your complete satisfaction throughout your ownership of our exceptional pellet stove.

At ComfortBilt, we firmly believe that you, our esteemed customer, are the cornerstone of our business. Your comfort and happiness are our topmost priorities, and we are dedicated to going above and beyond to exceed your expectations. It is our sincere pledge to work tirelessly, day in and day out, to ensure that your experience with our pellet stove is nothing short of extraordinary.

To assist you in getting the most out of your pellet stove, we have taken great care to curate a wealth of educational and informative resources on our website, www.comfortbilt.net. These invaluable articles, videos, and guides have been designed with your needs in mind, aiming to empower you with the knowledge and tools to maximize the performance and efficiency of your pellet stove. We want you to enjoy every moment spent in the comforting embrace of its warmth and reliability.

Once again, we extend our deepest gratitude for choosing ComfortBilt. Your trust in us inspires and motivates us to continuously improve our products and services. Please know that we are always here for you, ready to lend a helping hand or address any questions or concerns you may have along the way.

Thank you for becoming a part of our wonderful ComfortBilt community!
Sincerely,

Glenn Turley

CEO

TABLE OF CONTENTS



GETTING STARTED	5
• Key Features and Benefits	
• Getting Familiar with your Stove	
• Getting Familiar with Internal Components	
• Fuel Guide	
INSTALLATION	9
• Tools & Supplies You May Need	
• Unpacking and Inspecting	
• Mounting the Control Panel	
• Placement	
• Clearances to Combustibles	
• Floor Protection	
• Venting	
• Installation Examples	
• Vent Termination Clearances	
• Smoke and Fire Safety Review	
• Connecting to a Power Source	
• Final Install Checklist	
OPERATION	22
• Control Panel Operation	
• Control Panel Display	
• Understanding Your Pellet Stove	
• Operational Modes	
• Remote Control	
• Settings	
• Pre-Burn Diagnostic Testing	
• Safety Startup Procedures	
• Characteristics of a Good Flame	
• Information Screen	
MAINTENANCE	34
• Introduction to Maintenance	
• Side Panel Access	
• Cleaning and Maintenance Reference	
TROUBLESHOOTING	41
• Introduction	
• Problem/Solution Reference	
WARRANTY & SUPPORT	46
• Warranty Coverage & Limitations	
• Customer Support Options	
APPENDICES	48
• Technical Specifications	
• Exploded View and Replacement Parts	
• Wiring Diagram	
• Service Notes	



Key Features and Benefits

1. Heating Capacity

- The HP42 is capable of heating areas up to 2,500 square feet, making it suitable for medium to large-sized rooms.
- With a BTU (British Thermal Units) output of 14,857 - 42,370 / hr., it delivers ample warmth to keep you comfortable during colder seasons.

2. Pellet Hopper Capacity

- The pellet hopper can hold up to 120 lbs. (100-110 lbs. usable) of wood pellets, allowing for up to 80 hours of burn time before refilling is required.

3. Heat Settings

- The HP42 offers adjustable heat settings, allowing you to customize the heat output according to your preferences and comfort level.
- You can easily control the stove's heat output to maintain a cozy and warm atmosphere in your living space.

4. Programmable Thermostat

- Our pellet stove is equipped with a programmable thermostat, enabling you to set desired temperatures for automatic operation.
- This feature ensures consistent heating and helps to optimize energy efficiency by maintaining the desired temperature without constant adjustments.

5. Remote Control

- The HP42 comes with a convenient remote control, allowing you to adjust settings and control the stove's operation from up to a 10' distance.
- This feature offers enhanced convenience and ease of use, putting control at your fingertips without the need to approach the stove.

6. Automatic Ignition

- Our pellet stove features an automatic ignition system, eliminating the need for manual lighting.
- Simply activate the ignition system, and the stove will automatically ignite, providing hassle-free and efficient operation.

7. Ash Pan

- The HP42 includes a removeable ash pan for easy removal of accumulated ash.
- Regular cleaning and maintenance are simplified, ensuring optimal performance and longevity of your pellet stove.

8. Safety Features

- Your safety is our top priority. The HP42 is equipped with various safety features, such as overheat protection and safety shutdown mechanisms.
- These safety measures provide peace of mind during operation, ensuring a secure heating experience.

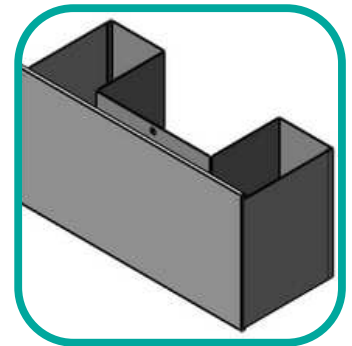
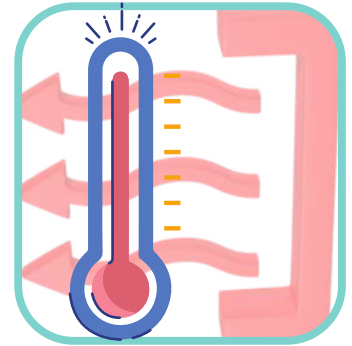

GETTING STARTED



Getting Familiar with your Stove



1. Control Panel - Main user interface board where all operational settings of the stove are stored. It allows you to control various functions and settings for optimal operation.

2. Hopper Lid Switch - Located under the hopper fill lid, this safety switch will stop the auger when lid is open.

3. Heat Tubes - Absorbs the heat from the fire and transfers that heat into the room.

4. Scraper Rod - Helps keep the heat tubes soot and carbon free for highest efficiency. Pulling it back and forth when the stove is cool will knock the ash from the heat tubes.

5. Side Panels - Side panels that provide access to the internal components and hide the latches and internals of the stove. They allow for easy maintenance and servicing of the stove when needed.

6. Pellet Drop Chute - Connects to the top of the pellet delivery auger system.

7. Front Door Latch - Tucked behind the right side panel, this latch will release the front door to allow it to open on the left side hinges.

8. Burn Pot - Cast iron pot where pellets are held while burning. It should be removed and cleaned out with every fill up of the hopper

9. Safety Placard - Provides important information, including serial number, date of manufacture, and other relevant details. It serves as a reference for safety guidelines and product specifications.

10. Data Cable - Data wire that connects the top control panel to the internal motherboard. It facilitates communication and data transmission between the control panel and other components of the stove.

11. Main Power Switch - Main power brick that includes power plug receptacle, fuses, and I/O toggle switch.

12. Air Intake Port - A 2-inch port designed for the intake of fresh air into the stove. It ensures proper combustion by providing a controlled airflow for the fire.

13. Exhaust Port - 75mm port used to connect the exhaust venting system. It allows the smoke and exhaust gases to exit the stove and connects to 3-inch piping for proper venting.

14. Room Temp Sensor - Sensor wire that reads ambient air temperature behind the stove. The house temperature is read out in the house symbol of the control panel.

15. Leveling Feet - Adjustable feet for leveling the stove.

GETTING STARTED



Getting Familiar with Internal Components

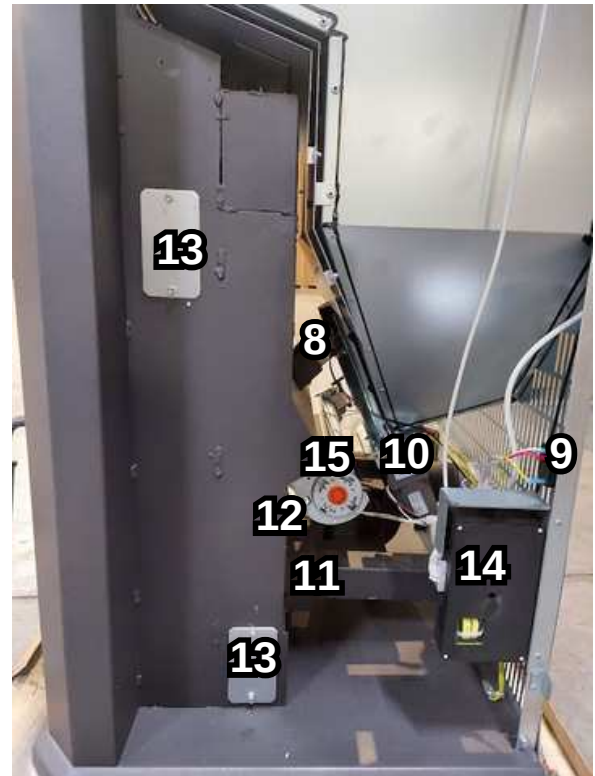
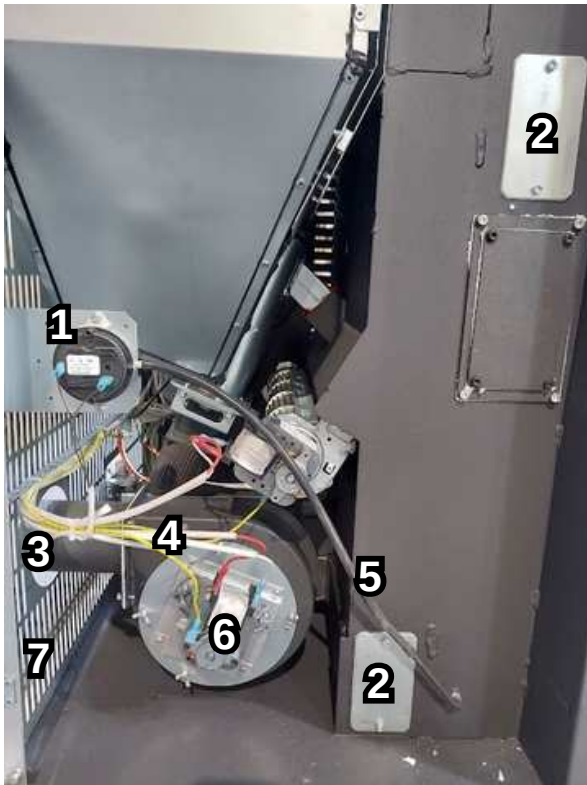

1. Vacuum Pressure Switch - This safety switch will engage when there is sufficient vacuum pressure. If this switch disengages during operation, the auger will stop feeding pellets.

2. Exhaust Side Ash Trap Cleanouts - Two of four cleanout locations that will periodically need to be cleaned. (See *Maintenance Section*).

3. Exhaust Hub - The 75mm exhaust port that a 3" appliance adapter will attach to in order to connect to the rest of the exhaust venting.

4. Proof of Fire Sensor - This is responsible for proving the fire to the computer. If this switch disengages, a "Low Temperature" alert will follow.

5. Vacuum Switch Hose Line and Elbow - Connects the vacuum switch to the main chamber.

6. Combustion Fan - Primary driver of all airflow in and out of the stove. This fan should start as soon as the stove is put into the Igniting phase of operation.

7. Rear Dust Guard - Safety shield that helps to protect the internals from pests and foreign debris.

8. Overheat Sensor - Located in a sleeve near the top of the auger system, this sensor will activate a "High Heat" alert if this area gets above 200°F (92°C).

9. Main Power Switch Connection / Wiring Harness - The main wiring harness will connect the power switch and all other AC components to the motherboard.

10. Auger Motor/Gearbox Assembly - Bolted to the underside of the hopper, the auger assembly is the device that feeds the pellets from the bottom of the hopper to the pellet drop chute.

11. Air Intake Pipe - Internal 2" pipe that will connect the firewall to the 2" intake piping, if used.

12. Igniter - The igniter is inserted into the igniter tube from the rear, and then secured into place.

13. Intake Side Ash Trap Cleanouts - One of two cleanout locations that will periodically need to be cleaned. (See *Maintenance Section*).

14. Motherboard/Circuit Board - Main electrical hub where all main AC components, switches, and sensors connect. (See *Wiring Harness*)

16. Room Blower/Distribution Fan - Blows the heat out of the heat exchanger tubes into the room. This fan engages when the stove goes into the Heating phase of operation.



Fuel Guide

Fuel Material and Storage

- Wood pellets are generally produced out of wood waste such as sawdust and shavings. The raw material is dried, mechanically fractionated to size and extruded into pellets under high pressure.
- This pellet stove is designed and approved to burn wood pellets, that comply with pellet fuels industry standards. Minimum of 40 lbs. density per cubic foot, 1/4" to 5/16" in diameter, with a maximum length of 1", and less than 1% ash.
- The performance of your pellet stove is greatly affected by the type and quality of the wood pellets you use. As the heat output of various quality wood pellets differ, so too will the performance and heat output of the pellet stove.
- We recommend trying various brands and types before purchasing single-ton or multi-ton lots to ensure satisfaction. A 5-bag sample of pellets will give a good indication of what to expect from a certain brand/type.
- Wood pellets need to be protected from direct exposure to moisture. Water, from sources such as condensation and humidity, causes pellets to expand and break down into unusable fuel.
- Store fuel in dry location, not within clearances to combustibles of your stove.
- It is important to select and use only pellets that are dry and free from dirt and debris. Dirty fuel will adversely affect the operation and performance of the unit, and can void the warranty. The Pellet Fuel Institute (PFI) has established standards for wood pellet manufacturers. Only use pellets that meet or exceed PFI standards for premium fuels.
- Depending on the source material, pellets may have differing ash contents.

Higher Ash Content Material:

- Hardwoods with a high mineral content.
- Fuel that contains bark and other impurities.
- Standard grade pellets.

Lower Ash Content Material

- Most softwoods.
- Fuels with low mineral or impurity content.
- Most premium grade pellets.

Pro Tip: We recommend using Pellet Fuels Institute (PFI) certified pellet fuel with this stove.

- The type of fuel you are burning will dictate how often you have to clean your fire pot.
- If the fuel you are burning has a high dirt or ash content, it may be necessary to clean the burn pot more than once per day.
- Poor quality fuel will cause clinkers to form in the burn pot. Clinkers are formed when non-combustible impurities are super heated and become glass-like.

Notice: Tested and approved for wood pellet fuel only. Burning any other type of fuel voids warranty. (*Cord wood, wood chips, corn, shells, cherry pits, etc.*)

WARNING!

Do Not Burn:

- Garbage, Lawn clippings or yard waste, Materials containing rubber, including tires, Materials containing plastic, Waste petroleum products, paints or paint thinners, or asphalt products, Materials containing asbestos, Construction or demolition debris, Railroad ties, or pressure-treated wood, Manure or animal remains, or Paper products, cardboard, plywood, or particleboard

Burning these materials may result in the release of toxic fumes or render the heater ineffective and cause smoke.



Tools and Supplies You May Need

- It's recommended to review the installation instructions provided in this manual and identify any additional tools or supplies specific to your installation setup.
- Ensure that all tools and supplies are in good condition and readily available before beginning the installation process.
- If you are unsure about any specific tools or supplies required, consult the ComfortBilt customer support or seek professional assistance.
- Before starting the installation of your ComfortBilt HP42 pellet stove, it is essential to gather the necessary tools and supplies. Here are some items you may need:

- | | | |
|--------------------------------------|-------------------------|-----------------|
| • High temperature silicone (500°F+) | • Tape measure | • Plumb Line |
| • Screwdriver | • Framing square | • Stud Finder |
| • Allen wrench set | • Reciprocating saw | • Utility knife |
| • Venting components | • Electric drill & bits | • Pliers |
| • Venting installation accessories | • Caulking gun | • Flashlight |
| | • Level | • Hammer |

Safety Equipment *(Recommended for all installation and maintenance steps)*

- Gloves
- Safety glasses
- Close-toed shoes



⚠ WARNING!

Inspect stove and components for damage.
Damaged parts may impair safe operation.

- Do **NOT** install damaged, incomplete, or substitute components.

Report damaged parts to dealer or manufacturer.

Substitute or damaged vent components may impair safe operation.

Pro Tip

- Odors and vapors are released during initial startup after purchase, and may persist for several days.
- Burning your stove on a higher level will speed the curing process.
- Open windows or doors for air circulation until curing/burn off is complete, or perform a "pre-burn" outdoors.

⚠ CAUTION!

- Risk of cuts, abrasions, or flying debris.
- Wear protective gloves and safety glasses during installation.
- Metal edges may be sharp.

Pro Tip: It is recommended that your pellet vent pipe be installed and serviced by a professional installer.

- Installation **MUST** comply with local, regional, state and national codes and regulations.
- Consult insurance carrier, local building inspector, fire officials, or authorities having jurisdiction over restrictions, installation inspection and permits.



⚠ CAUTION!

Take appropriate precautions to locate utilities within the wall and avoid contact.

INSTALLATION



Unpacking and Inspecting

When you receive your Comfortbilt HP42 pellet stove, it is important to carefully unpack and inspect it to ensure all components are present and in good condition. Follow these steps:

Unpacking:

- Carefully remove any packaging materials, including the cardboard lid, outer box sleeve, packing foam, and the cardboard packing material inside the main chamber.
- Set aside the packaging materials for disposal or recycling.
- Unscrew the mounting L brackets that secure the rear of the stove to the pallet. (4mm Allen)
- Open hopper lid and remove control panel, power cord, remote control, and all literature from the hopper. (See checklist to the right)

Inspecting:

- Pellet stove body: Inspect the main body of the pellet stove for any visible damage, dents, or scratches.
- Side Panels: Ensure the side panels open and close smoothly without obstruction. (see side panel access).
- Hopper: Verify the hopper's integrity and check for any cracks or deformities.
- Glass window: Examine the glass window for any cracks, chips, or signs of damage.
- Door assembly: Ensure the door assembly opens and closes smoothly without any obstructions.
- Ash pan: Check the ash pan for any signs of damage or deformation.
- Venting components: If included, inspect the vent pipes, elbows, termination caps, and connectors for any damage or missing parts.
- Control panel: Check the control panel for any visible damage and ensure that all buttons and displays are in working order.
- Fans: Check that both the room blower fan and combustion blower fan spin freely when manually spun by hand.
- If any components are missing or damaged, contact the dealer or retailer where you purchased the stove for assistance.

Inside the Hopper, you will find:



Note: It is important to keep the packaging and any protective materials until the installation process is complete and the stove is fully operational. These materials may be needed in case of returns, exchanges, or relocation.

Mounting the Control Panel

- Remove all four Phillips mounting screws along the top rear of the stove where you wish to mount the controller bracket.
- Line up the holes in the back to the mounting bracket and secure in place. (Note: Universal mounting brackets are used, so only the far left and two right screws align. This is normal, and will still secure the panel to the stove)
- Find the data cable line at the rear of the stove, and plug it snugly into the back of the control panel. (This 4-wire clip will only plug in one way.)
- The universal mounting bracket will also allow for the control panel to be mounted to the side farthest from the exhaust port for specific vertical venting scenarios. (The two left and the far right screws are used in this case).

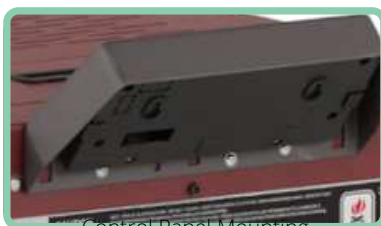

Control Panel Mounting

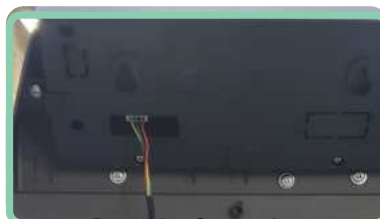

Data Wire Connection



Side Mounting



Placement

The proper location for your ComfortBilt HP42 pellet stove is crucial for its safe and efficient operation. Consider the following factors when choosing a suitable location.

1. Efficiency:

- Proper airflow is crucial for efficient combustion in a pellet stove. Installing the stove in a spacious main floor living room allows for better air circulation and ventilation, optimizing combustion and heat production. In contrast, a tighter space or basement with limited air can lead to inadequate oxygen supply, incomplete combustion, and reduced efficiency.

2. Clearance requirements:

- Check the manufacturer's recommendations and local building codes to determine the required clearances from combustible materials, such as walls, furniture, curtains, and other objects.
- Ensure that there is ample space around the stove for proper airflow and maintenance access.
- Maintain the specified clearances to prevent the risk of fire and ensure optimal performance.

3. Floor suitability:

- Place the pellet stove on a stable, non-combustible floor surface that can support its weight.
- Consider the floor's ability to withstand the heat generated by the stove, especially if it is a combustible flooring material.
- Use a non-combustible hearth pad or floor protector under the stove, as required by local regulations.

4. Ventilation:

- Place the stove in an area with adequate ventilation to allow for proper combustion and venting of the pellet stove's byproducts.
- Avoid installing the stove in tightly enclosed spaces or areas with poor airflow, as it may lead to inefficient operation or indoor air quality issues.
- Ensure that the chosen location allows for the installation of venting components according to the manufacturer's instructions and local building codes.

5. Accessibility to a power source:

- Ensure that the chosen location has access to a suitable electrical power source.
- Avoid using extension cords or power strips as a primary power connection.
- If necessary, consult a qualified electrician to ensure proper wiring and adherence to electrical safety codes.

6. Safety considerations:

- Avoid installing the stove in high-traffic areas or places where children or pets can easily access it.
- Ensure that the stove is positioned away from flammable materials, such as curtains, rugs, and furniture.
- Take into account any local regulations or guidelines related to stove placement, especially in terms of proximity to combustible materials and heat exposure.

Be sure to refer to local building codes and regulations to ensure compliance and safety. If you are unsure about any aspects of the installation, seek professional assistance from a qualified installer or contact ComfortBilt customer support for guidance.

INSTALLATION



Clearances to Combustibles

- Confirm required clearances to combustibles (Combustibles include wood, drywall, etc...)

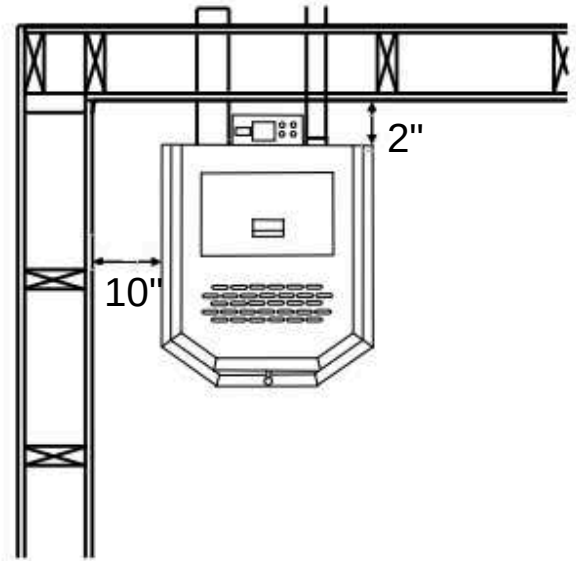
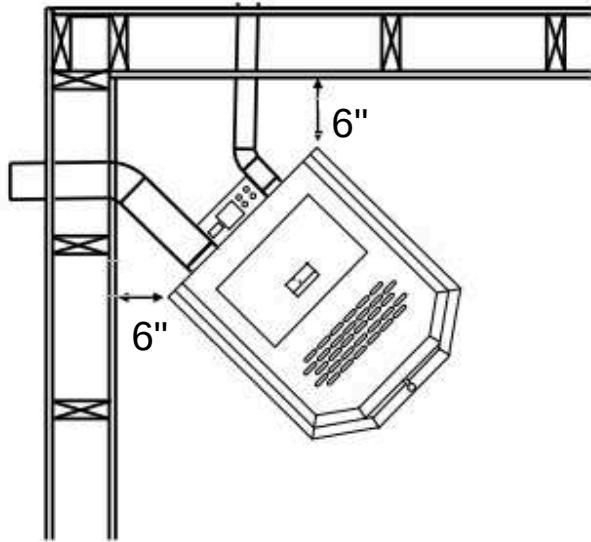

Horizontal installation

- Back walls to Stove rear corners: **6" (15cm)**
- Back wall to Stove back: **2" (5cm)**
- Side wall to Stove: **10" (26cm)**

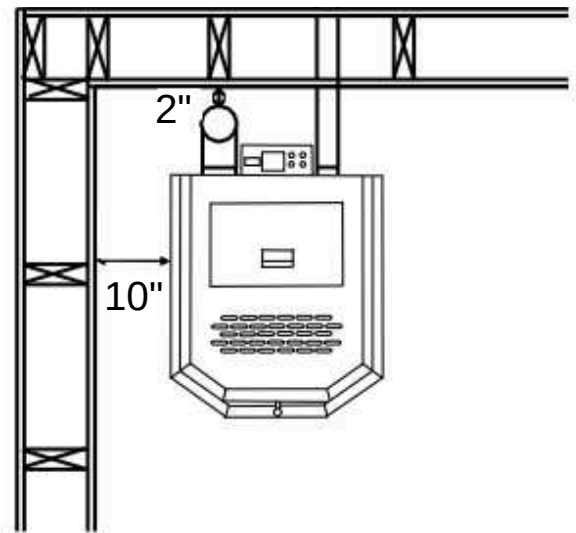
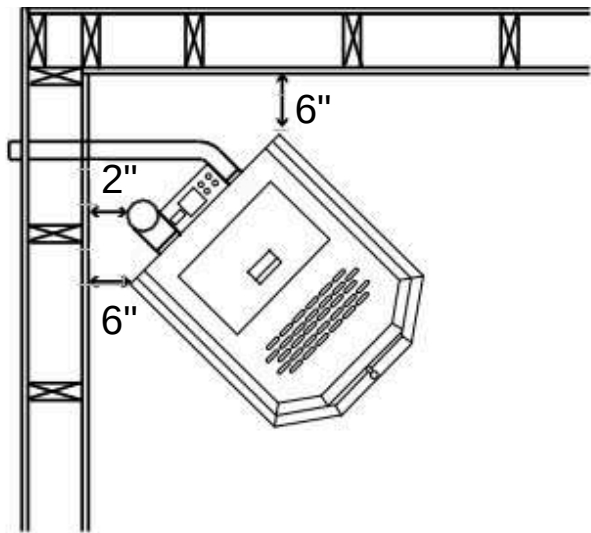

Vertical installation

- Back walls to Stove rear corners: **6" (15cm)**
- Back wall to pellet pipe: **2" (5cm)**
- Side wall to Stove: **10" (26cm)**

Notice: When interior vent is installed vertically, the clearance to the back wall is determined by the vent size used. Install vent at clearance specified by the vent manufacturer. Take into consideration any upward turning elbows or tees.

INSTALLATION

Scan the QR Code to explore our complete range of Hearth Pads.



Floor Protection

Floor Protection

Non-combustible material (such as a hearth pad) is required underneath your stove.



Notice: Be careful to protect the bottom of the stove and floor surfaces when moving the stove. Bottom edges of the stove may be sharp and can scratch surfaces.

To ensure safe installation of the stove, please follow these guidelines for floor protection:

1. The stove should be placed on a noncombustible floor or a masonry hearth.
2. If a clean out T-vent is installed inside the home, the floor protector must extend 2 inches beyond the rear of the T-vent.
3. When venting the stove straight through the wall with the clean out T-vent on the exterior, maintain a minimum clearance of 2 inches between the back of the stove and the wall.
4. Install Ember Protection, which is a type 1 floor protector specifically designed for this stove.
5. The floor protector should be made of non-combustible material and extend beneath the stove. It should have a minimum of 6 inches (152mm) in front of the glass and 6 inches (152mm) on both sides of the stove.
6. For horizontal venting, the non-combustible floor protection must extend 2 inches (51mm) beneath the flue pipe. For vertical installation with a top vent adapter, the floor protection should be placed under the adapter. *(Please note that this guideline is required in Canada and recommended in the USA.)*

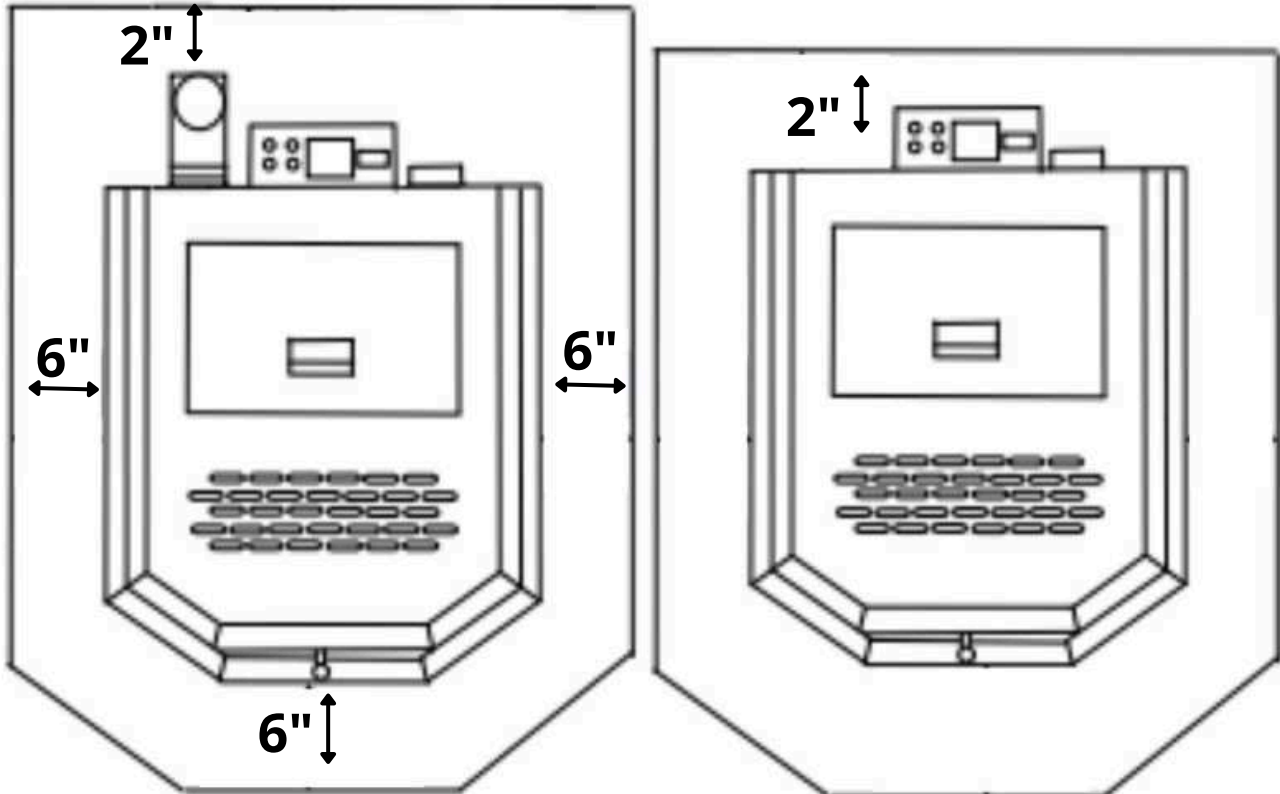

*This will satisfy safety standards for both USA and Canada

Notice: Clearances may only be reduced by means approved by the regulatory authority having jurisdiction.



Venting

Required: Only use a 3" or 4" type "L" or "PL" pellet venting system (such as DuraVent or Selkirk).

Follow these steps for proper venting installation:

1. Contact local building or fire officials about restrictions and installation inspection requirements in your area.
2. Contact your local authority (such as municipal building department, fire department, fire prevention bureau, etc.) to determine the need for a permit.
3. Mark and cut the exterior wall if necessary for venting penetration.
4. Use a 3" appliance adapter as the first connection to the stove's exhaust port as required.
5. Secure the appliance adapter to the stove's exhaust port using a high-temperature (500°F+) sealant, such as RTV silicone.
 - The connection to the stove should be secured with at least 3 screws. (Check with your piping manufacturer's specifications, as you may also be required to secure each joint with screws and/or sealant as well).
 - If venting horizontally, joints should be made gas tight by using a high temperature sealant, or inner gaskets within the piping, as specified by the piping manufacturer's specifications.
6. Install a wall thimble if necessary according to the manufacturer's specifications.
 - Use an approved wall thimble when passing the vent through walls.
 - Use a ceiling support/fire stop spacer when passing the vent through ceilings. (Make sure to maintain minimum clearances to combustibles).
 - Use a sealant, such as silicone, to create an effective vapor barrier where the chimney or any component penetrates the structure's exterior.
7. Install pellet venting through the wall and connect the vent/pipe to the stove.
 - The pellet venting pipe, also known as L vent, consists of two layers with air space in between. This design acts as insulation, reducing the outside surface temperature to allow clearance from combustibles.
 - For elevations above 5,000 feet, it is recommended to use 4" venting.
 - Some venting manufacturers offer pellet stove adapters for easier installation.
 - If using more than one T-vent or exceeding 180° of elbows, the use of 4" venting pipe is recommended. (See *EVL calculations on following page*)
 - Horizontal sections of vent pipe should always maintain a 1/4 inch rise per foot. We recommend using the shortest venting and fewest elbows possible when venting horizontal.
 - Due to the potential for fly ash accumulation in horizontal venting sections, the maximum permissible horizontal venting length is 4 ft.
 - When the venting is on the exterior of the structure, use a support bracket every 5' of vertical pellet vent.
8. Follow the pipe manufacturer's instructions to seal all pipe joints securely.
9. Install the termination cap.
10. Ensure all required clearances to combustibles are met for the stove.

Pro Tip: When it comes to vertical movement of the stove, utilize the bottom adjustable leveling feet. These feet allow you to make vertical adjustments of up to 3/4", ensuring proper positioning and stability.

Pro Tip: Consider installing a clean-out "T" (sold separately) when venting the stove vertically. This additional component can greatly assist in the periodic cleaning and maintenance process, saving you time. However, please be cautious about the potential for leaks when installing an interior Tee.

⚠ CAUTION!

- Do **NOT** connect to any air distribution duct or system.
- Do **NOT** install a flue damper in the exhaust venting system of this stove.
- Do **NOT** Connect this stove to a chimney flue serving another appliance.



Venting (Continued)

To ensure optimal performance of Comfortbilt pellet stoves, it is crucial to consider the equivalent vent length (EVL) and the impact of exhaust bends. The combustion fan relies on unrestricted airflow for efficient combustion. However, adding bends in the exhaust path restricts air flow, reduces stove performance, and creates a collection point for ash deposits, requiring more frequent cleaning. Therefore, when selecting a location for the appliance, prioritize a venting system with the shortest EVL and minimize the use of bends. This will maximize combustion efficiency, enhance performance, and reduce the need for frequent cleanings.

The following chart shows the maximum allowable equivalent vent length for a 3" and 4" venting system as well as the EVL for common pellet vent components.

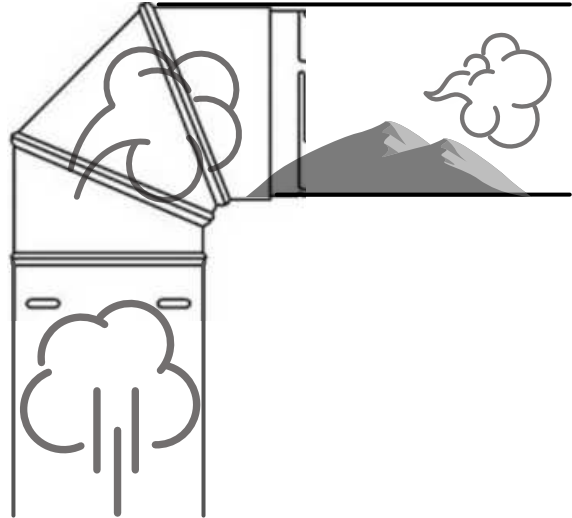

Maximum allowable equivalent vent length:

- 15 EVL for 3" pellet vent pipe or liner
- 25 EVL for 4" pellet vent pipe or liner
- When connecting 2 elbows consecutively, with no piping separation between them, add +2 EVL Units.

Equivalent Vent Length:

- 90° Elbows or Tee: (Each) 5 EVL Units
- 45° elbow: (Each) 3 EVL Units
- Horizontal Pipe or liner: (Per Ft.) 1 EVL Units
- Vertical Pipe or Liner: (Per Ft.) ½ EVL Units

Outside Air Intake (available separately):

- Connecting the intake pipe (2" diameter pipe at the rear of the stove) to the exterior of the house is REQUIRED for mobile home installations. It is also recommended for tightly sealed homes with exhaust fans, such as kitchen or bathroom fans, or for basement installations. This is important to eliminate poor stove performance caused by negative pressure.
- Please note that only noncombustible pipe with a diameter of 2" or greater is approved for outside air connections. It is crucial to avoid connecting PVC pipe to the stove, as it is NOT approved and should NEVER be used.
- When connecting the air inlet to the outside, it is imperative to terminate it with a vertical 90° bend down or with a wind hood, and a rodent screen.. Failure to do so may result in a burn-back if high winds blow directly into the air inlet during a power outage.
- To ensure sufficient combustible air supply to the stove, it is important to avoid blockages, excessive length (over 8 ft.), or excessive bends in the air intake pipe. These factors could lead to inadequate airflow and result in the stove not receiving enough combustible air.
- During the off-season, to prevent excessive moisture from entering the stove, remember to remove and/or cap the intake.
- Use an air intake kit, available for purchase from Comfortbilt, or attach intake piping to the rear of the stove with a clamp, and install a weather hood and rodent screen outside to help protect the stove's internals.

Notice: The operation of exhaust fans, such as bathroom and attic fans, could create a negative pressure in the room, causing the stove to be starved of combustible air. Be sure to provide adequate ventilation in the room the pellet stove is located. If not, the vacuum pressure switch may shut off the operation of the pellet stove. Consider using an outside air intake for optimal performance.

Special Note: You can find examples of different types of installations on the following pages:

- Page 16 illustrates simple installation styles that are typically installed using a 3" venting system.
- Page 17 showcases more complex installations typically done using a 4" venting system.

These examples will provide visual references and help you understand the varying configurations and setups that can be utilized for your pellet stove installation.

INSTALLATION

Simple Horizontal Installation

Scan the QR Code to explore our complete range of Piping

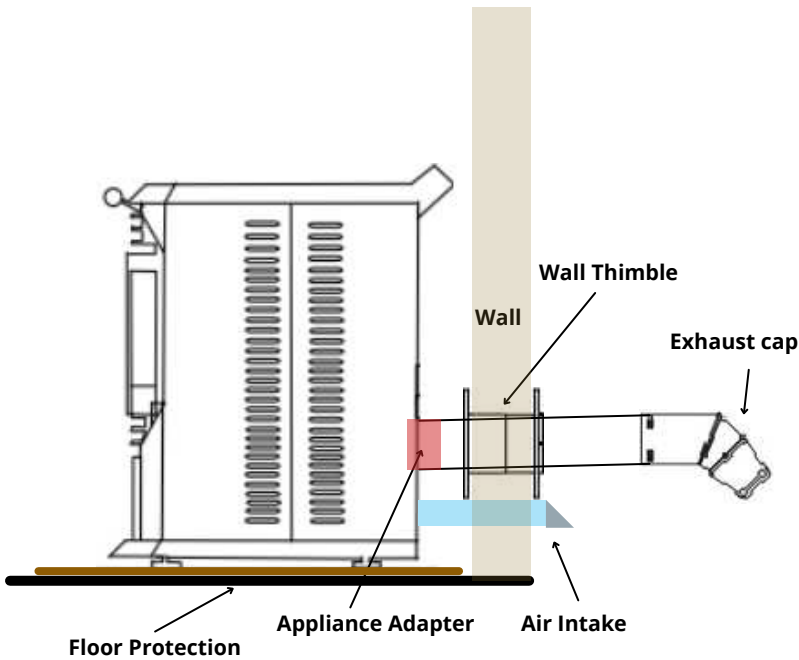

Notice: Please ensure that you use an exhaust cap that is approved and equipped with a spark arrestor. This will help restrict the release of embers through the venting system and enhance overall fire safety measures.

Mobile Home Installation

Installation in a mobile home should be in accordance with the manufactured home and safety standard (HUD), [CFR 3280, Part 24](#). This stove must be vented to the outside. In addition to the standard installation instructions, the following requirements are mandatory for installation in a mobile home:

- The stove must be permanently attached to the floor.
- Stove must have an outside air source.
- Stove must be electrically grounded to the steel chassis of the mobile home, unless properly grounded outlets are provided.
- All vertical chimney vents must have wall supports.
- All exhaust systems must have a spark arrestor.
- Check with local building officials to see if other codes may apply.

⚠ WARNING!
DO NOT INSTALL IN A SLEEPING ROOM.

⚠ CAUTION!
The structural integrity of the manufactured home floor, wall, and ceiling/roof must be maintained.

Simple Vertical Installation

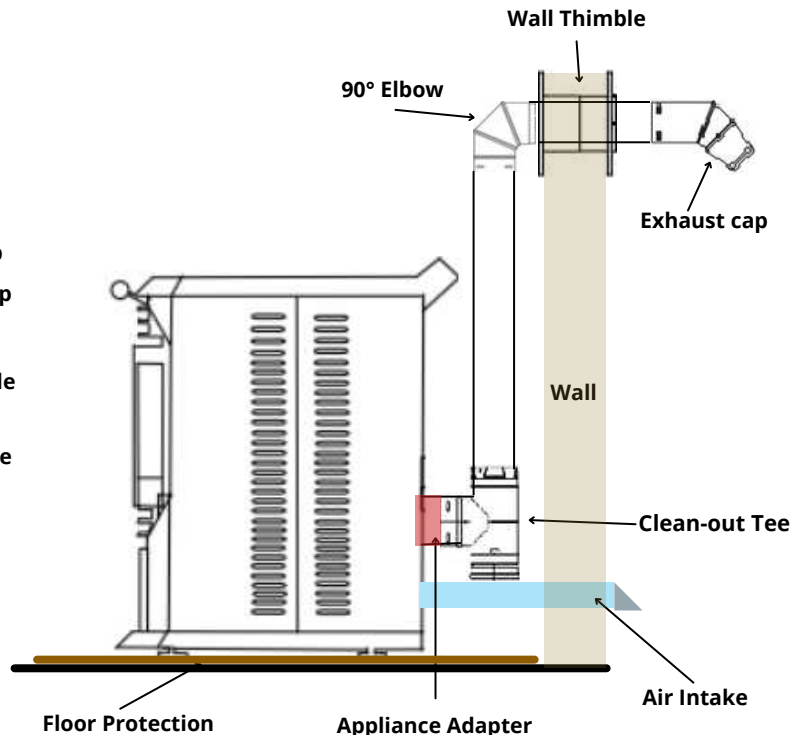
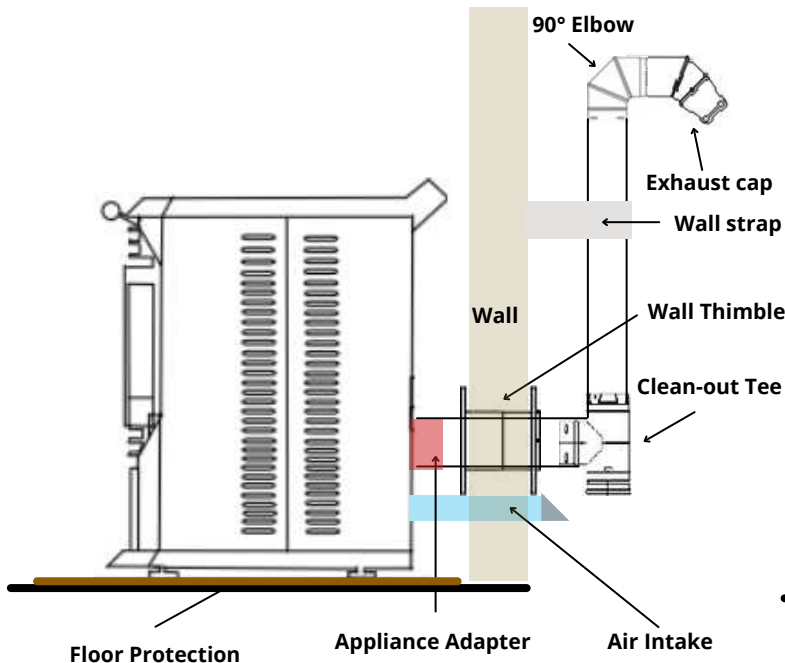

Notice: For Canada, the installation must conform to CAN/CSA-B365

INSTALLATION

Scan the QR Code to explore our complete range of Piping



Through Roof Vertical Installation

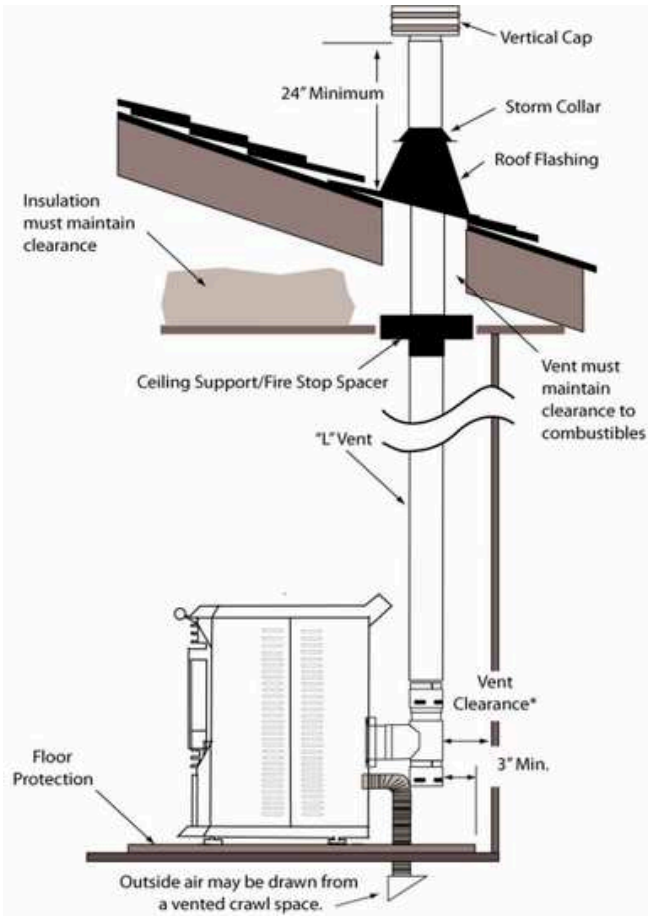

Class A Chimney Retrofit Installation

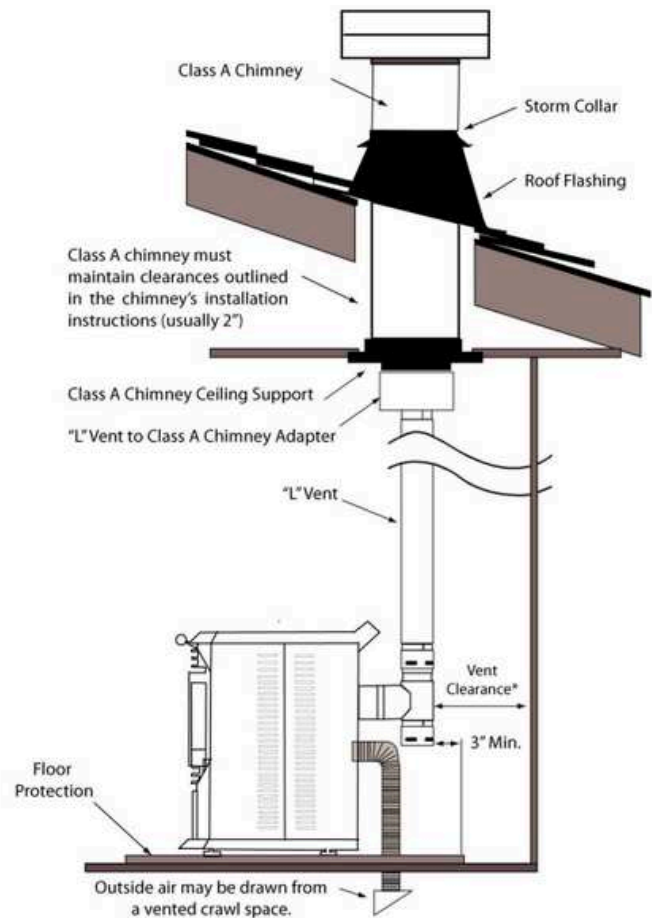

Masonry Fireplace Hearth Install

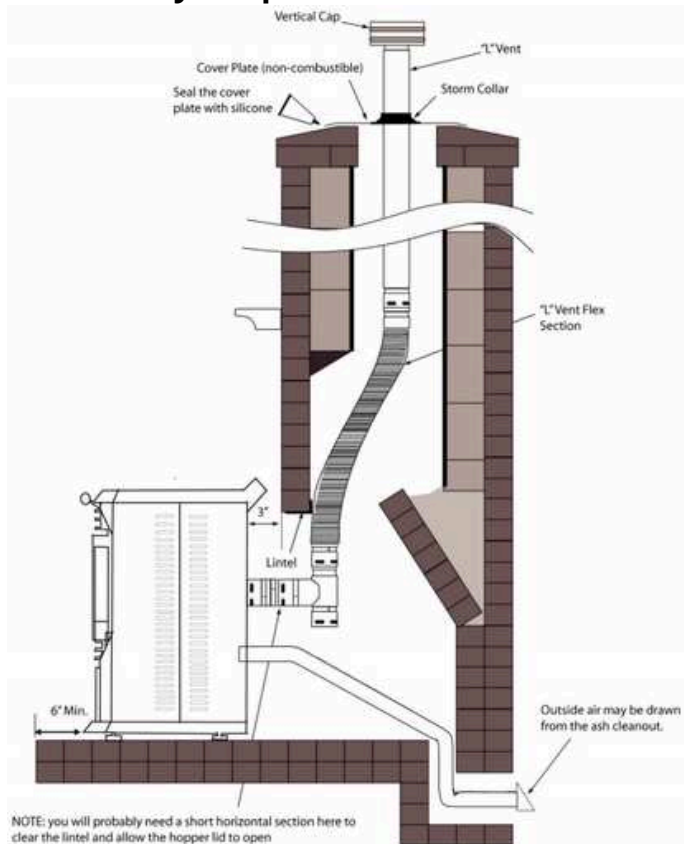

Freestanding Masonry Chimney install

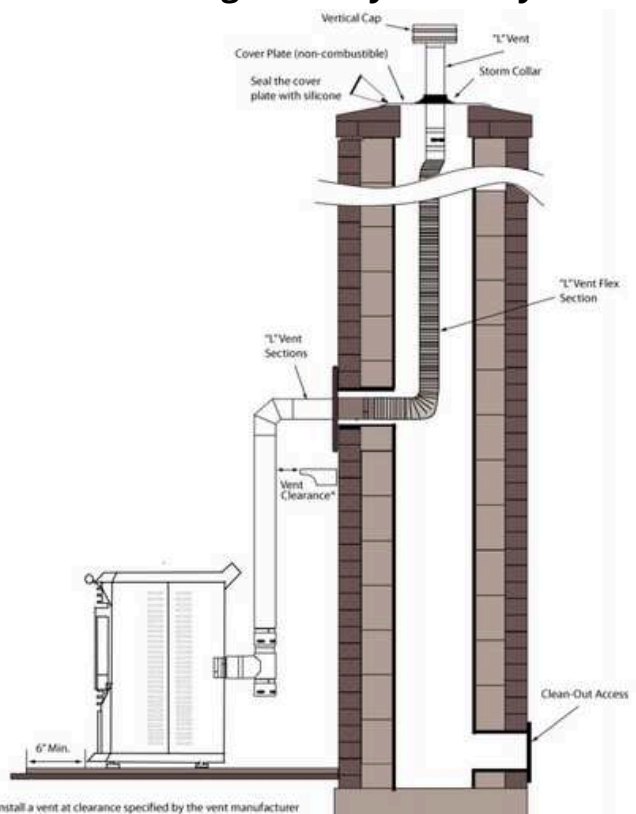

INSTALLATION

Scan the QR Code to explore our complete range of Piping



Vent Termination Clearances

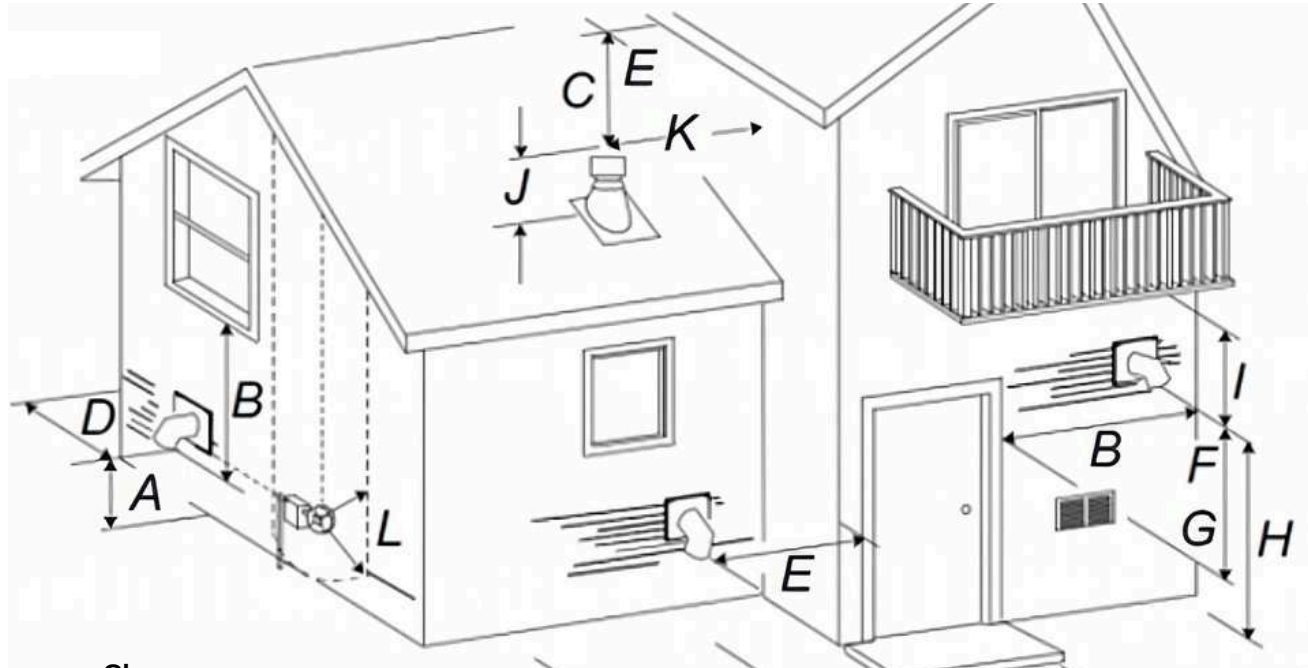

Clearance

A	24 Inches	Clearance above grade, porch, deck, or balcony. (including Vegetation.
B	48 Inches	Clearance beside or below any windows or doors that open.
	12 Inches*	Clearance above any windows or doors that open.
	18 Inches*	Clearance below windows and doors if outside intake air is used.
C	18 Inches	Vertical clearance to ventilated soffit located above the terminal within a horizontal distance of 2 feet from the centerline of the terminal.
D	0 Inches	Clearance to an outside corner wall.
E	12 Inches	Clearance to an inside combustible corner wall or combustible obstructions.
F & G	48 Inches	Clearance to an air supply inlet or intake of another appliance.
H	7 Feet**	Clearance above a paved sidewalk or driveway located on public property.
I	24 Inches**	Clearance under a veranda, porch, deck, or balcony.
J	24 Inches	Clearance above the roof.
K	24 Inches	Clearance from an adjacent wall, including neighboring buildings.
L	3 Feet within a height of 15 feet above the meter	Clearance to each side of center line, extended above natural gas or propane meter/regulator assembly or mechanical vent.

* Recommended to prevent condensation on windows and thermal breakage

** This is a recommended distance. Check local codes for additional requirements.



Vent Termination (Continued)

NOTICE:

To ensure proper venting of the stove, follow these guidelines for termination clearances:

- The stove vent must terminate outside the building.
- Horizontal terminations should extend at least 12" from the wall, while vertical terminations must protrude at least 24" from the roof surface.
- Use an approved cap or a 45-degree downturn with a rodent screen to prevent water from entering.
- If the termination is on a windy side of the house, consider using an approved house shield to prevent soot buildup on the house.
- Avoid locations where the vent can be blocked by snow or other materials.
- Do not terminate the vent in a way that allows flue gases or soot to enter or stain the building.
- Avoid terminating the vent in enclosed or semi-enclosed areas such as carports, garages, attics, crawl spaces, sun decks, porches, narrow walkways, or areas that can accumulate fumes.
- Do not terminate the vent below the air inlet.
- When venting directly through a wall, it's recommended to install at least 3 ft of vertical pipe to create a natural draft, preventing smoke or odor from venting into the home during a power outage.
- Maintain a minimum of 18" separation between the exhaust termination and the intake vent, keeping the exhaust termination at a higher point.

Adhering to these guidelines will ensure proper ventilation and prevent potential hazards or nuisances.



⚠ CAUTION!

Ensure that your stove venting terminates above the stove and that the venting always follows a 1/4" rise per foot or the follow may occur:

- Improper drafting.
- Smoke may seep into the house.
- Excessive soot.

Smoke and Fire Safety Review

1. Heat radiation:

- The surface of the pellet stove can become hot during operation. Take precautions to prevent accidental contact and burns.
- Keep flammable materials, such as curtains, furniture, and decorations, at a safe distance from the stove to avoid heat-related hazards.

2. Carbon monoxide (CO) and smoke detectors:

- Install carbon monoxide (CO) detectors and smoke detectors in the vicinity of the pellet stove.
- Regularly test and maintain these detectors according to the manufacturer's instructions to ensure their proper functioning.

3. Fire safety:

- Keep a fire extinguisher nearby in case of emergencies.
- Develop and practice a fire escape plan with all occupants of the building, ensuring everyone knows how to exit safely in the event of a fire.

4. Regular inspections and maintenance:

- Routinely inspect the pellet stove for any signs of wear, damage, or malfunction.
- Clean the stove and venting system as recommended by the manufacturer to maintain optimal performance and reduce the risk of fire.

5. Children and pet safety:

- Supervise children and pets around the pellet stove to prevent accidental contact or burns.
- Use safety gates or barriers to restrict access to the stove when it is in operation.



Connecting to a Power source

Proper electrical connection is essential for the safe and reliable operation of your ComfortBilt HP42 pellet stove. Follow these guidelines for connecting the stove to a power source:

Outlet / breaker selection:

- It is recommended to use a dedicated 15A (or more) breaker for the electrical circuit powering the pellet stove.
- This dedicated breaker helps ensure that the stove receives sufficient power and reduces the risk of overloading the circuit.
- Choose a dedicated electrical outlet near the stove for connection.
- Ensure that the outlet provides the required 115V 60Hz power output and is easily accessible.
- Adhere to local electrical codes and regulations when selecting the outlet location.
- To ensure uninterrupted service for your pellet stove, please avoid using GFCI outlets or outlets equipped with dimmer or variation controls.
- The wiring should be capable of handling the power load of the stove without overloading the circuit.
- Ensure that the electrical outlet used for connection is grounded or consult an electrician to ensure proper grounding if needed.

Pure sine wave power output:

- The HP42 requires a pure sine wave power output signature.
- Certain power backup systems, such as generators, may not provide a pure sine wave and may not work properly with the stove.

Surge protector:

- To protect the sensitive electronics of the pellet stove, a surge protector is required.
- A surge protector helps prevent voltage spikes and fluctuations, reducing the risk of damage to the stove's electronics.
- Choose a surge protector with appropriate voltage and joule rating for the stove's power requirements.

Power cord:

- Inspect the power cord of the stove for any signs of damage, such as cuts or frays.
- Route the power cord in a manner that avoids kinks, sharp bends, or excessive strain.
- Keep the power cord away from heat sources, sharp objects, or areas where it may be tripped over.
- Never use extension cords or power strips as a primary power connection for the stove.

Testing:

- After connecting the stove to the power source, perform a test to ensure proper electrical connection.
- Turn on the stove and verify that all control panel functions and indicators are operational.
- If any issues or abnormalities are observed, immediately disconnect the power and consult the manufacturer or a qualified technician for assistance.

Safety precautions:

- It is important to adhere to local electrical codes at all times, and if you have any uncertainties, consult a certified electrician for guidance.
- Always exercise caution when working with electricity.
- Avoid modifying or tampering with the electrical components of the stove.

Electrical Ratings: 115 Volts AC, 60 Hz

- **Startup:**
 - 4.01 Amps / 481W
- **Running on High:**
 - 1.86 Amps / 214W



Final Install Checklist

Before proceeding with the first burn, it is important to perform a final installation checklist to ensure that all components of the ComfortBilt HP42 pellet stove are properly aligned and in place. The installation process may cause some components to shift out of alignment, so it is crucial to ensure everything is properly aligned before proceeding.

Physically inspect and verify the following components:

Venting System:

- Inspect the venting system to ensure it is correctly connected, sealed, and free from any blockages or restrictions.

Flooring:

- Verify that the stove is placed on a non-combustible floor or appropriate floor protection, following the recommended guidelines.

Clearances to Combustibles:

- Double-check all clearances to combustibles, including walls, furniture, and other potential fire hazards, as specified in the manual.

Electrical Connections:

- Ensure that all electrical connections, such as power supply and control panel connections, are securely and correctly made.

Door Security:

- Confirm that all doors, including the front door and hopper lid are able to be closed tightly and securely.

Hopper Inspection:

- Check that no foreign materials, debris, or obstructions have fallen into the hopper, which could impede pellet flow.

Igniter Position:

- Verify that the igniter is in a good position, properly aligned, and securely mounted. The igniter should be centered in the tube and recessed no more than $\frac{1}{2}$ ". (*This distance can vary between igniter styles*)

Fan Functionality:

- Carefully spin the combustion and convection blower fans by hand to ensure they rotate freely without any resistance or unusual noises.

Boot Up:

- Flip the main power switch at the back of the stove to the "On" position (- is on, 0 is off).
- The panel will boot up, displaying the logo screen and the current program being used. It should read: "HP42_U01 115V 60Hz" quickly before displaying the home screen.

OPERATION

Control Panel Operation



1. **Infrared Receiver:** Receives signal from the remote control. *(Included)*
2. **Power Indicator:** Illuminates green when stove is turned on.
3. **Alarm Light:** Illuminates red when a fault is encountered or when Combination Function button is pressed.
 - Alarm codes include: *Low Temperature, High Temperature, Ignite Failed, etc. (see troubleshooting section for more information)*
4. **On/Off Button:** Starts and stops operation of the stove.
5. **Information Button:** Allows you to read the real-time status of the stove at any time.
6. **Mode Select Button:** Allows you to set the unit to one of four operational mode settings: Manual, Temp, Weekly, and Thermostat.
 - Thstat mode requires wired thermostat to work correctly. *(See wiring diagram)*
7. **Combination Function Button:** After you press this key, the red alarm indicator light will illuminate. You can then press another key on the below list to complete a specific operation.
 - Button 4: Child Lock
 - Hold On/Off button (4) for three seconds to activate child lock.
 - Hold Exit button (9) for three seconds to disengage child lock.
 - When activated, a key symbol will display at the top, and the panel operations will be locked out.
 - Button 6: Sleep Timer
 - Use scroll up and down to change the number of hours you wish to set it for.
 - Once set, the stove will run for that duration before automatically shutting down.
 - Button 11: Auger Priming / Feeding On
 - This will put the auger into a constant feeding cycle. *(Displays "Feeding On" message)*
 - Typically used when priming the auger, or during auger lubrication maintenance.
 - Button 9: Stop Auger / Feeding Off
 - Press this to pause the feeding. *(Displays "Feeding Off" message)*
8. **Scroll Up Button:** Allows you to scroll up to choose items in the menu.
9. **Exit Button:** Takes you out of current selection and returns to previous option and/or screen.
10. **Scroll Down Button:** Allows you to scroll down to choose items in the menu.
11. **Enter Button:** Pressing the "Enter" button allows you to adjust and select data on the screen. Pressing and holding the "Enter" button for 3 seconds will take you the "Set Data" menu, where you can alter settings such as time, combustion, and weekly schedules.

**CR2032
Lithium
Battery**

**On-Board
Speaker**

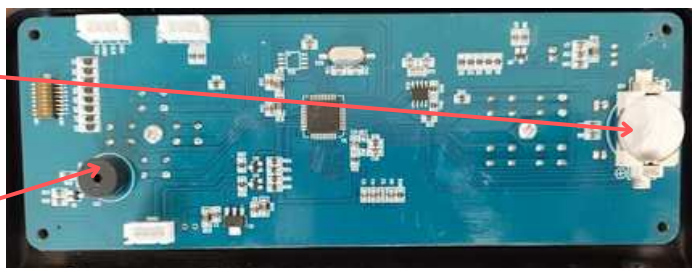

Notice: In the event the stove loses power, a 3V CR2032 Lithium battery, installed in the panel, should hold all of the user settings. Such as: Weekly schedules, Temperature units, and Day/Time



Control Panel Display

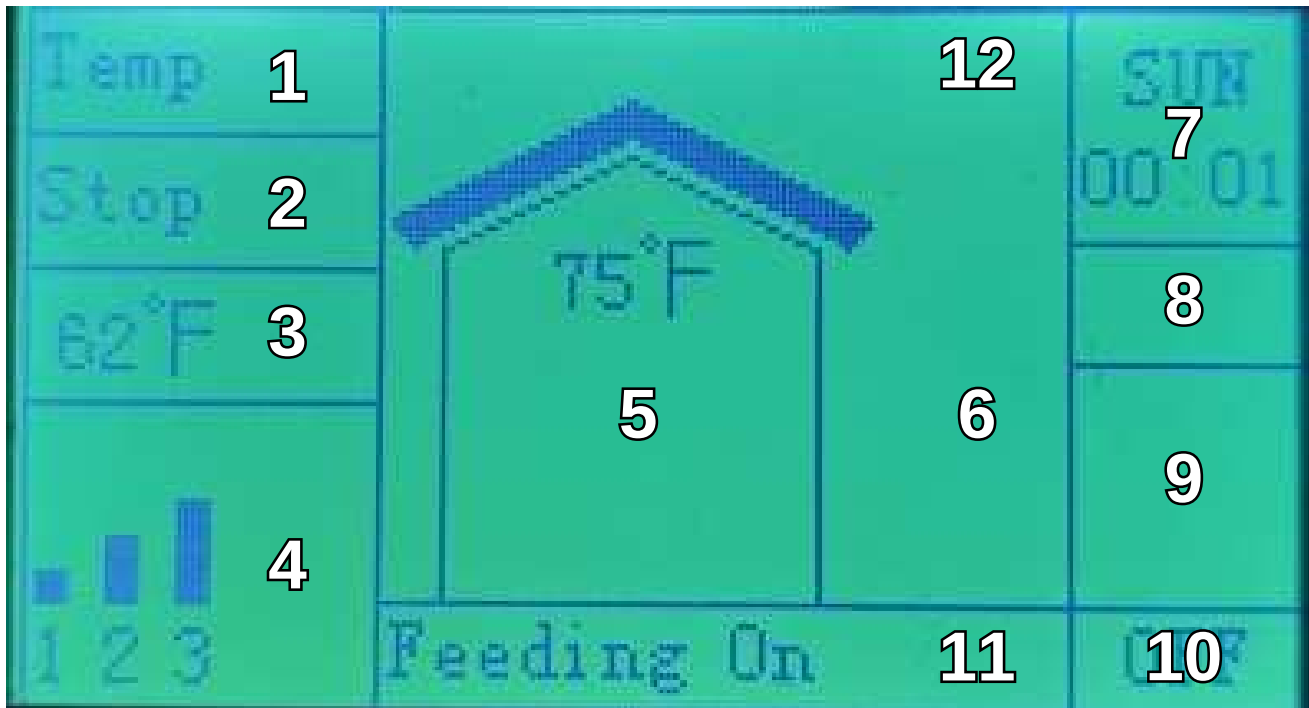

1. **Mode:** Displays the current operation mode.
 - a. *Manual, Temp, Weekly, or Thstat.*
2. **Work Stage:** Also called the "Phase Line", Displays the operational stage or phase the stove is currently in.
 - a. *Igniting, Heating, Fire Off, Cleaning, Standby, Stop, etc.*
3. **Desired Temperature:** In Temp or Weekly mode, this will show the currently set temperature.
4. **Heat Power Level:** Displays the current set Heat level.
 - a. *In Manual mode, you can directly set this. In other modes, this will change automatically, based on other requirements set by the stove*
5. **Current Temperature:** Displays the temperature that is being read by the room temperature sensor wire.
6. **Current Time Period:** In weekly mode, this displays the current time setting for the next programmed time block.
7. **Day and Time:** Displays the day of the week and current time.
8. **ECO Mode Indicator:** Indicates when ECO is currently active.
 - a. *ECO allows the stove to cycle on and off automatically in the Temp mode.*
9. **Safe Mode Indicator:** If the vacuum or limit switches are being bypassed, the stove will display the word "Safe Mode" in this box. *(See Settings for more info)*
10. **On/Off Indicator:** Indicates if the stove is on and in operation or in the process of shutting down.
11. **Information Bar:** Displays real-time messages.
 - a. *such as "Feeding On" when performing auger priming for instance*
12. **Child Lock Indicator:** Indicates when child lock is currently active.
 - a. *Child lock will lock the panel so no other buttons can be pressed*
 - b. *If you see the Key symbol, press and hold the Exit button  for 5 seconds to unlock.*



Understanding Your Pellet Stove

During the startup process of the ComfortBilt HP42 pellet stove, you can expect the following sequence of events:

1. Combustion blower turns on ("Igniting" displayed).
2. Igniter heats up.
3. Auger delivers pellets to the burn pot (some smoke may occur).
4. Convection blower activates once the stove heats up ("Heating" displayed).
5. Both blowers continue running even after shutdown ("Fire off" displayed).

- Your stove utilizes a vertical auger fuel feed system that is operated by a microprocessor controlled digital circuit board. The digital circuit board allows the vertical auger fuel system to run in a timer based, non-continuous cycle. This cycling allows the auger to run for a predetermined amount of time. The auger pushes pellets up a chute located in the hopper. The pellets will then turn and fall through another chute into the burn pot.
- Your stove is equipped with an automatic ignition system that should ignite the fuel within 5 minutes of displaying "Igniting".
- As pellets fill the burn pot and ignite, outside air is drawn through the fuel and heated during the combustion process which is then pulled across the heat exchange tubes by the exhaust motor.
- Adjusting the air damper between the approved ranges (75% to 100% open) may allow you to find the perfect combustion setting for your application. There is a mechanical stop to prevent closing of this damper beyond 75% open.
 - The air damper is preset at 75% allowable air, which is preferable in most applications. Opening this damper when installed into a space with lower air availability, such as basements, may be beneficial.
- As the stove reaches operating temperature, the room air is then circulated through the heat exchange tubes by a room air blower (convection blower), distributing warm air into the room.
- The amount of heat that is produced by the stove is proportional to the rate of fuel that is burned.
- Because a forced draft pressure is required for the combustion process inside the stove, it is extremely important that the exhaust system be properly installed and maintained.
- Front glass and ash pan doors must remain closed while in operation and the seals on the doors must be properly maintained.



⚠ WARNING! Fire Risk:

Keep combustible materials, gasoline, and other flammable vapors and liquids clear of the stove.



- Do NOT operate stove with door open.
- Do NOT operate stove without the ash pan drawer in place.
- Do NOT operate stove without burn pot in place.
 - Only use the approved Burn pot for this pellet stove. Use of grates, 3rd party log sets, or other fuel support is prohibited.
- Do NOT store flammable materials in the stove's vicinity.
- Do NOT use gasoline, lantern fuel, kerosene, lighter fluid or similar liquids to start or "freshen up" a fire in this stove. (Keep all such liquids well away from the stove while it is in use, as combustible materials may ignite.)



Operational Modes

Before starting your ComfortBilt HP42 pellet stove, it is important to select the desired operating mode for optimal functionality. The stove offers four modes: Manual, Temp, Weekly, and Thstat.

1. **Manual Mode:** In this mode, you have control over the heating power level. You can adjust and set the level from 1 to 5 to achieve the desired heat output.
2. **Temp Mode:** In this mode, you can set the desired room temperature. The stove will automatically adjust the heating power level to maintain the selected temperature. Enabling the ECO option in the settings allows the stove to cycle on and off automatically to maintain the desired temperature.
3. **Weekly Mode:** This mode allows you to schedule the stove's operation according to your preferences. You can program specific days and times for the stove to automatically operate. You can set different programs for each of the seven days of the week, with up to four periods per day.
4. **Thstat Mode:** This mode utilizes a simple wired thermostat to control the fire-on and fire-off cycles of the stove.

To select the desired mode, use the mode select button  on the controller. Pressing this button will cycle through the available operating modes. The current mode is displayed in the upper left-hand corner of the screen.

It is crucial to choose the mode before turning on the stove. Attempting to change the mode while the stove is already burning may cause the stove to shut down, resulting in a 30-minute cool-down delay before restarting. It is not necessary to start the stove's operation to select the mode. Locate the mode select button on the controller to make your mode selection

Manual Mode: In Manual Mode, you have the flexibility to adjust the heat levels of the ComfortBilt HP42 pellet stove, allowing you to increase or decrease the amount of heat it produces.

- To modify the power level in Manual Mode, use the "Scroll Up" or "Scroll Down" buttons on the control pad.
- Each press of these buttons will adjust the power level by one increment.

Please note that Manual Mode enables you to directly control the heat output using a scale of 1 to 5 bars, rather than adjusting specific temperatures. For temperature control, you can refer to the Temp Mode.



Temp Mode: In Temperature Mode, you have the ability to set your desired room temperature. The stove will automatically adjust the heat level to maintain the room temperature close to your desired setting.

- To adjust the "Call to" temperature, simply use the "Scroll Up" or "Scroll Down" buttons on the control pad. The current room temperature and the set "Call to" temperature will be displayed in the temperature display box on the screen.
- When the room temperature falls below the set "Call to" temperature, the stove's heat power level will automatically increase to the maximum level of five.
- Once the desired temperature is reached and maintained for about a minute, the heat power level will return to one, remaining at that level until additional heat is required.



Please note that in Temperature Mode, the stove will not shut off or go into standby. Instead, it will idle and continue producing a fire until the room temperature falls below the set "Call to" temperature. During idling, the heat power level will be indicated as level one on the display screen's power level box. To enable the stove to cycle off and on automatically, make sure to turn on the ECO option in the "Settings" section.



Operational Modes (Continued)

Weekly Mode: In Weekly Mode, you have the ability to schedule and control the operation of the stove during specific times and days throughout the week. You can set up to four different operation times for each of the seven days.

- When the stove is operating in Weekly Mode, it functions similarly to the "Temp" mode. As part of the weekly schedule program, you can also set a desired "call to" temperature for each scheduled period.
- For detailed instructions on programming the weekly schedule, please refer to the "Set Data" section.

IMPORTANT: It is essential to set your weekly schedule in Weekly Mode before starting a fire. If you try to set a weekly schedule while the stove is already running in Manual or Temp modes, the schedule will not be set, and the screen will prompt you to wait until the stove is turned off and has cooled down before attempting to set the schedule again.

Thstat Mode: Thstat Mode allows you to control the stove using a wired remote thermostat. However, please note that the stove will only operate in this mode if it is connected to a compatible thermostat.

- A thermostat acts as a temperature-activated switch. When the thermostat signals a demand for heat, you will see an "ASKED" message displayed on the screen. This indicates that the stove has received the request and will automatically ignite and start running to generate heat.
- Conversely, when the thermostat no longer requires heat, you will see a "NONE" message on the screen. In response, the stove will enter a fire off mode, allowing the fire to gradually die down. Eventually, the stove will transition into standby mode, ready for the next call for heat.
- Please ensure that your stove is properly connected to a thermostat for Thstat Mode to function correctly.



Connecting a Thermostat: Connect the "Call for Heat" extension wires from the thermostat to the bottom circuit board.

- Open the right side or rear panel to access the circuit board.
- Remove the lid by removing the 4 Philips screws in the corners. (*You can unscrew the bottom L bracket to make it easier to access the board.*)
- Connect the thermostat pigtail lead wire (*sold separately*) to the plug labeled "Level" as shown.
- Splice the pigtail wire into the existing thermostat wire.
- Connect thermostat wire to thermostat on the proper "Call for Heat" connections.



Remote Control

All Comfortbilt pellet stoves come with an infrared remote that can control the panel.

To activate the remote, pull the plastic battery separator tab from the back battery compartment.

- **On** - This button will start the stove (similarly to pressing the power button on the panel)
- **Off** - This button will stop the stove (similarly to pressing the power button on the panel)
- **Manual** - This button will put the stove into Manual mode
- **Temp** - This button will put the stove into Temperature control mode.
- **Up** - This button will increase the heat level (in Manual mode) or the set temperature (in Temp mode).
- **Down** - This button will decrease the heat level (in Manual mode) or the set temperature (in Temp mode).
- **Hold and Unhold** - These buttons no longer do anything, as they were for a previous version.







When the stove is started from the remote control, the panel backlight will stay off.

This remote control uses a 3V CR2025 Lithium battery.

Settings

There are a number of settings that can be altered or adjusted within your stove. (*Weekly schedules, Time/date, temperature units, etc.*)

- Press and hold the Enter button  This will take you to the "Set Data" screen.
- Use the Scroll Up () and Scroll Down () buttons to navigate through the list, and then press the Enter button to select.
- Press the Exit button  at any time to back out of your current menu or selection. Pressing the Exit button while at the Set Data menu screen will bring you back to the Home Screen. (*After a few minutes of inactivity, the panel will time out and go back to the Home screen*)

Here is a brief description of each of the menu items.

A full description of each menu is available later in this section.

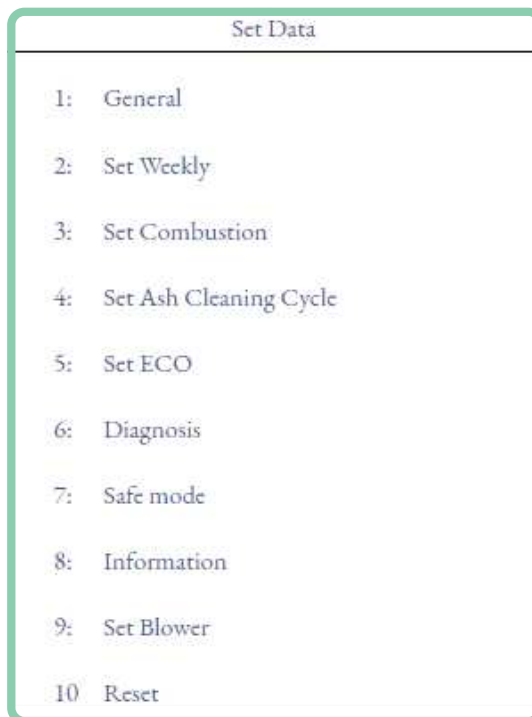

1: General - In this menu, you can configure settings related to Time/Day, Temperature unit (Celsius or Fahrenheit), Language, and Wifi.

2: Set Weekly - Use this menu to create a weekly program schedule for the stove when it's in the Weekly Operation mode. You can set up to four on/off cycles per day.

3: Set Combustion - Technicians can adjust the feed rates, exhaust voltages and blower voltages for each Heating or Ignition level in this menu.

4: Set Ash Cleaning Cycle - Customize the automatic ash cleaning schedule for each Heating level using this menu.

5: Set ECO - Enable or disable the ECO function in this menu. When activated, the stove will cycle on and off based on the desired temperature set in the Temp mode.

6: Diagnosis - This menu allows you to perform independent tests on each of the main components of the stove for diagnostic purposes.

7: Safe Mode - Technicians can use this menu to bypass one or both of the internal safety switches that can turn off the auger. The switches are known as Limit and Vacuum.

8: Information - Access specific information about the stove in this menu, including running info, stove info, and Wifi history.

9: Set Blower - This menu is not applicable to our pellet stoves, as it is intended for devices without blower fans, such as boilers. It allows you to toggle the room blower fan on or off, and is password protected.

10: Reset - Use this menu to restore the panel programming to the factory defaults, erasing all user settings in the process.



Settings Continued

1: General - This menu has four internal settings.

1. Time and Day
2. Temperature Units
3. Language
4. Wifi Reset / On

- Time and Day: Press Enter to select and highlight the block you wish to edit, use the Up and Down buttons to change the value, and then press Enter again to lock in your edits and highlight the next block.
- Temperature Units: Press Enter to highlight. Use the Up and Down buttons to change between temperature units (*C* or *F*) and then press Enter to confirm your selection.
- Language: Press Enter to highlight. Use the Up and Down buttons to select your desired language, then press Enter to confirm your selection.
- Wifi Reset / On: Press Enter to highlight either the Reset or On option, press the Up or Down button to change the value, and then press Enter again to confirm your selection. (*This option is reserved for future expansion for a wifi adapter, that is not built into the control panel.*)

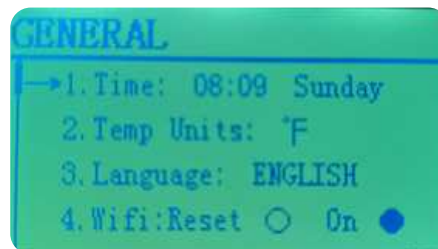

2: Set Weekly - This menu allows you to set up a weekly run schedule for your stove (*for each day*), and will have four independent time blocks. Each block will have the following:

1. Ignite On Time (*24 hour clock / Military time displayed*)
2. Fire Off Time (*24 hour clock / Military time displayed*)
3. Desired Temperature
4. Use Line Item (*Yes / No*)

- Press the Enter button to highlight the Day, press the Up or Down buttons to select the Day you wish to edit, and then press Enter again to confirm your selection.
- Press the Down button to move the cursor arrow down to your first program block.
- Press the Enter button to highlight the "Ignite On time" Hour block, press the Up or Down buttons to change the value, then press Enter again to confirm and highlight the "Ignite On time" minute block. Use the Up and Down buttons to edit the value. Press Enter to confirm, and highlight the next block.
- Press the Enter button to highlight the "Fire Off time" Hour block, press the Up or Down buttons to change the value, then press Enter again to confirm and highlight the "Fire Off time" minute block. Use the Up and Down buttons to edit the value. Press Enter to confirm, and highlight the next block.
Note: The earliest time you can turn the stove on is 00:00 (*Midnight*) and the latest time you can turn the stove off is 23:30 (*11:30pm*) *This forces a minimum 30 minute shutdown between 23:30 and Midnight the next day.
- Press the Up and Down buttons to select the desired temperature while the stove is running. (*61°F - 82°F*) and press Enter to select and highlight the last block.
- Use the Up and Down arrows to select either Yes or No. (*Yes means to use this line, No means to ignore this line.*) Press the Enter button again to confirm.
- Repeat this process for lines 2 - 4 as desired to set up your weekly schedule.
- To replicate the same program for every day of the week, scroll up to the ALL item at the top right, and press the Enter button twice. (The panel will beep twice to indicate that the program was copied to all days of the week)
- Once set, ensure that the Mode is set for "Weekly" and that the stove is turned to the ON position. (*lower right*)



3: Set Combustion - This menu is reserved for authorized personnel to make changes as needed, on an individual basis.

- This menu is password protected to prevent creating a potentially dangerous situation.
- Only Comfortbilt authorized dealers, repair technicians, or technical support representatives can alter any combustion settings.



Settings Continued

4: Set Ash Cleaning Cycle - This menu has three options that are set for a specific heating level. (H01 - H05)

- Press the Up and Down arrows to navigate to the line item you wish to edit, and press Enter to highlight.
- Press Up and Down to edit the value, then press Enter again to confirm.

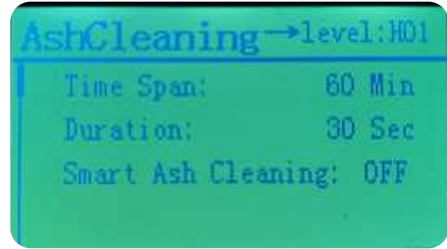

1. **Time Span:** Controls the time span between cleaning cycles. (Minutes)

2. **Duration:** Controls how long the cleaning cycle will last. (Seconds)

3. **Smart Ash Cleaning:** Allows the stove to use a pre-set range of numbers. Gives the option for Light, Medium, and Heavy cleaning cycles. *(Activating this option will gray out the Time Span and Duration options)*

When the stove enters into a "Cleaning" phase, the feeder will pause, and the exhaust fan will increase to let some of the buildup of ash in the burn pot get blown free. *(If you experience a very small flame or "Low Temperature" alerts during this cleaning cycle, reducing the Duration value to 20 Sec or less on level: H01 may help)*

5: Set ECO - This menu lets you toggle on or off the ECO function, which will allow the stove to automatically cycle on and off based on the desired temperature set in the Temp mode.

- Press the Enter button to highlight the Off or On tag.
- Press the Up or Down button to edit the value, and then press Enter to confirm.

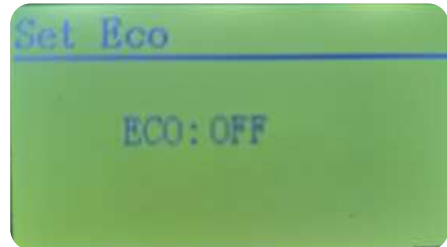

When ECO is set to ON, and the stove is operating in the "Temp" mode, the stove will go into "Fire off" mode and shut down when the actual temperature *(in the house)* meets or exceeds the desired, or call to, temperature *(left side of screen)*

Once the exhaust housing is cool, and the actual temperature falls below the desired temperature, then the stove will automatically reignite.

This On/Off cycle will continue until interrupted or turned off.

***ECO will cause considerable wear on the igniter, and require more electricity during the added ignition phases.**

6: Diagnosis - This menu allows you to independently test each of the main components of the stove. You can only enter into the Diagnosis menu when the stove is off and the work stage line shows "Stop" *(at the top left, below the Operational mode)*

- Press the Enter button to cycle through the four main components. Fire, Exhaust, Feed, and Blow.
- Pressing the Up button will place a shaded circle next to the selected component and activate that device.

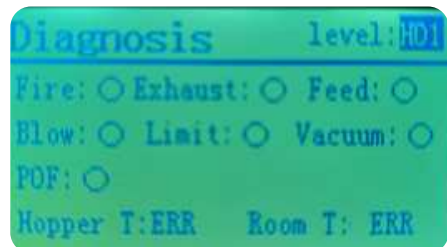

Level: This lets you simulate what level the activated device will run at. (H01 - H05)

Fire: Putting a shaded circle here will engage the Igniter.

(Once activated the igniter should glow at the tip within 3 minutes)

Exhaust: Putting a shaded circle here will engage the combustion fan.

Feed: Putting a shaded circle here will engage the auger system and feed pellets. *(at the level indicated)*

Blow: Putting a shaded circle here will engage the room blower fan.

Limit: This will engage and become shaded when the hopper lid is closed.

Vacuum: This will engage and become shaded when the main chamber is under negative pressure.

(anytime the combustion fan is running)

POF: *(Proof of Fire)* This will engage when the exhaust housing is hot. *(above 130° F)*

Hopper T: This will display the current temperature of the Hopper temp sensor. *(Alerts above 197°F)*

Room T: This will display the current temperature of the room. *(Room temperature sensor behind stove)*



Settings Continued

7: Safe Mode- This menu allows service technicians to bypass one or both of the internal safety switches that have the authority to stop the auger from feeding for testing and diagnosing purposes.

⚠ CAUTION!

- Bypassing safety switches can create dangerous situations, and is reserved for technicians only.

8: Information - This menu allows you to view some specific information about the stove. (See *information screen on following page*)

- Press the Up or Down button to select the submenu you wish to view, and then press Enter to confirm.
- There are three information submenus.
 1. Running Information
 - This submenu will display running information, and will display a screen that is similar to the diagnosis menu that shows which devices are currently engaging. (see #6 Diagnosis)
 2. Stove Information
 - This submenu will display stove information such as: Total ignite times, total running time, and program and power information.
 3. History WIFI Information
 - This Submenu will display wifi history information. (*Programmed future expansion*)

9: Set Blower - This menu allows the room blower fan to be toggled On or Off. (*This menu is not used for our pellet stoves, but for devices that do not use blower fans such as boilers*)

- Password protected; there is no reason to alter this.
- Setting the Blower to OFF would prevent the stove from being able to transfer internal heat out into the room, and could cause the stove to overheat and shut down.

10: Reset - This menu will let you reset the programming in the panel to the stored factory defaults, and you will lose all of your user level settings.

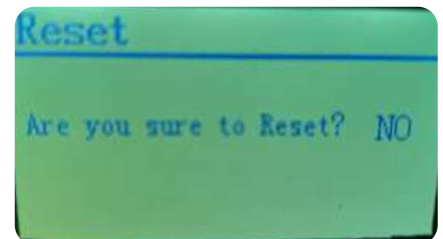
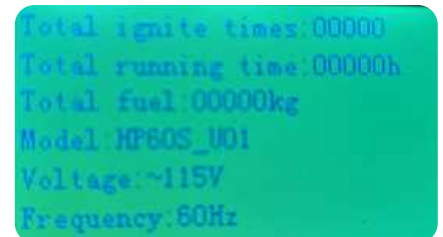
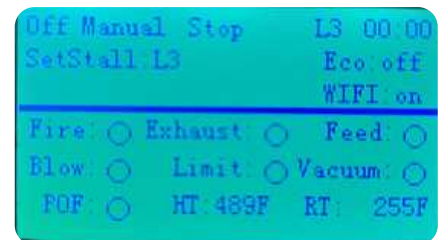
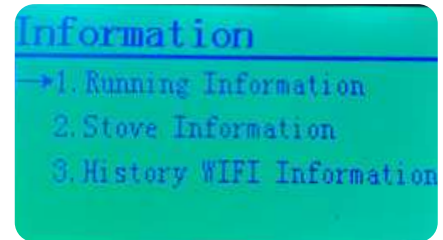

- Press the Enter button to highlight NO.
- Press the Up button to change the NO to YES.
- Press the Enter button again to confirm.
- The computer will reboot back to the home screen with default settings.













Pre-Burn Diagnostic Testing

Before operating your stove, it is important to ensure that all components are functioning correctly. Follow the steps below to check your components in diagnostics mode:

- To enter diagnostics mode, press and hold the Enter button  for 3 seconds.
- Use the down arrow button to navigate to option 6: Diagnosis, and press Enter button  again to access.

In diagnostics mode, you can test various components, including the igniter, exhaust fan, blower fan, and more. Follow the steps below to check each component:

- **Hopper Lid Switch Testing:**
 - The bubble next to "LIMIT" should be darkened when the hopper lid is closed.
 - Open the lid and observe if the circle un-darkens when it opens.
- **Igniter Testing:**
 - Press the Enter button  to highlight the word "FIRE".
 - Press the up arrow button once to shade the bubble to the right of the word "FIRE."
 - Open the front door of the stove and remove the burn pot. Look for the igniter tube, where you should see the red glow of the igniter tip within three minutes. *(Some igniters may glow quicker).*
 - Press the up arrow key once to un-darken the circle and turn off the igniter.
 - Put the burn pot back in and close the combustion chamber door.
- **Combustion Fan Testing:**
 - Press the Enter button  to highlight the word "EXHAUST."
 - Press the up arrow key once to darken the circle next to "EXHAUST."
 - Listen for the fan to come on and check if the circle to the right of "VACUUM" is darkened, as the switches work together. *(ensure that the front door and ash pan are both latched during this test)*
 - Once confirmed, press the up arrow key once to turn off the exhaust fan.
- **Auger Testing:**
 - Open the hopper lid to view the auger shaft inside.
 - Press the Enter button  once to highlight the word "FEED."
 - Press the up arrow key once to darken the circle next to "FEED" and observe if the auger bit is turning. It operates on a timed cycle, so it will turn and stop intermittently.
 - Press the up arrow key to un-darken the circle.
- **Blower Fan Testing:**
 - Press the Enter button  once to highlight the word "BLOW."
 - Press the up arrow key once to darken the circle and listen for the blower fan to come on.
 - Ensure you can feel air flow approximately three feet off the stove's vent.
- **Exiting:**
 - Press the Exit button  twice to return to the home screen.
- **Loading the Pellet Hopper:**
 - Ensure the hopper is filled with wood pellets. Refer to the "Fuel Guide" section in the manual for the appropriate type of pellets to use.
 - Open the hopper lid and carefully pour the pellets into the hopper, avoiding any spillage or introduction of foreign objects.
 - Close the hopper lid securely, ensuring there is no pellet material on the seating surfaces.
- **Prime Auger:**
 - Prime Auger - Now test and prime the auger system. Press the Combination Function button  (A red indicator light will come on). Then the Enter button . A "Feeding On" message will display on the screen, and the auger will engage to slowly draw pellets into the drop chute. After about a minute, pellets should start dropping into the burn pot. Once pellets start to feed, press the Combination Function button  again (the red indicator light will go out).
 - Ready to start - The stove is now ready to start. (Empty any extra pellets from the burn pot before igniting)
 - Priming is only required the first time the stove is lit, or after hopper has been emptied for cleaning and maintenance.
- **Ready to start:**
 - The stove is now ready to start. Remember to empty any extra pellets from the burn pot before igniting. *(See Safety Startup Procedures)*



Safety Startup Procedures

Ensure Clean Burn Pot:

- Before initiating the ignition sequence, ensure that the burn pot is completely clean and free from any fuel residue or debris. Cleaning the burn pot helps prevent potential issues such as delayed ignition, excessive smoking, puffing starts, and the risk of creating large fires. Additionally, inspect and clear any obstructions from the air holes surrounding the burn pot to promote proper airflow and efficient combustion.

Ensure Proper Burn Pot Seating:

- When placing the burn pot onto the cradle, make sure it is seated securely without any gaps or spaces that could allow air to escape. A tight seal between the burn pot and the cradle is vital for optimal combustion and to prevent air leakage, maximizing efficiency and heat generation.

Secure Front Door:

- Check that the front door of the stove closes tightly and latches securely. Similarly, ensure the ash pan is properly seated with no gaps or misalignments. This maintains efficiency and prevents any disruptions.

Check and Fill the Hopper:

- Confirm that the hopper is fully filled with pellets, reaching the underside of the fill lid. Ensure the hopper lid closes tightly, and check that the hopper lid switch engages correctly when closed. The switch ensures the auger operates only when the hopper lid is securely in place.

Select Mode & Start Ignition:

- Choose the desired mode on the stove, then press the On/Off button to initiate the stove's operation. Listen for the sound of the exhaust fan engaging and observe the pellets falling into the burn pot. Within a few minutes, the igniter will reach high temperatures, igniting the pellets and producing a fire.

Monitor the Ignition Cycle:

- During the ignition cycle, it is crucial to closely monitor the stove until the flame is fully established. Never leave the stove unattended during this time. If you notice excessive smoke or if the fire takes longer than 5 minutes to establish, follow these steps:
 - Press the On/Off button once to turn off the stove. (*OFF will display in the lower right corner*)
 - Press and hold the On/Off button for 5 seconds. (*IGNITING will change to display FIREOFF in the phase line at the upper left corner*)
 - Allow the stove to fully cool and then restart the ignition process from step 1, which is cleaning the burn pot.

Notice: Ignition sequences require an empty burn pot. Fuel and residue in the burn pot can cause delays in ignition, excessive smoking, puffing starts, and oversized fires.

Characteristics of a Good Flame

A properly functioning flame exhibits specific characteristics. Look for an active torch-like flame with a bright yellow center. Additionally, observe streaks of blue near the bottom of the burn pot, indicating sufficient airflow pressure. The resulting ash should reduce to a fine light gray powder.

Conversely, signs of improper combustion include gritty brown ash and fuel being expelled from the pot before complete reduction. These indicate excessive air pressure under the burn pot.

Dark or black ash and sluggish, darker flames suggest an air shortage.

Here's what to expect at different heat levels:

- **1 Bar:** At this level, the fire height may vary due to a lighter feed schedule. On average, the top of the flame should be slightly above the lip of the burn pot.
- **3 Bars:** The fire at this level should form a relatively stable torch, reaching approximately halfway up the chamber.
- **5 Bars:** The flame at this level will be tall, with the tops of the flames extending to about the underside of the heat tubes.





Information Screen

At any time, you can access the Running Information screen by pressing the Information button once.

Top Half of the Screen:

The top half of the screen provides essential running information, including:

- **On/Off Status:** Indicates whether the stove is currently in operation or turned off.
- **Current Heating Level:** Displays the current level at which the stove is heating. (*Set Stall L1-L5*)
- **Current Run Time:** Shows the duration for which the stove has been running.
- **Eco and WIFI Indicators:** Indicates the status of Eco mode and Wi-Fi connectivity.

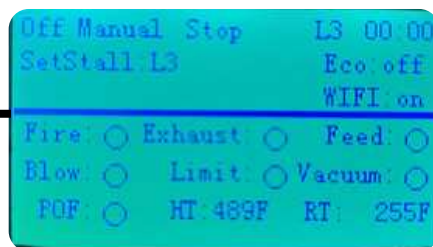

Bottom Half of the Screen:

The bottom half of the screen offers a real-time diagnostic readout, providing insights into the operation of various components and temperature readings. Here's a legend to help you understand each component:

- **Fire (Igniter):** When shaded, it signifies the signal being sent to the igniter to start the fire. This shading will disengage once the stove reaches the operating temperature and enters the Heating phase.
- **Exhaust (Combustion Blower):** When shaded, it indicates the signal sent to the exhaust fan for air movement during combustion.
- **Feed (Auger):** This bubble will shade on and off in accordance with the auger feed schedule.
- **Blow (Convection Room Blower):** When shaded, it means the stove has reached the operating temperature and entered the Heating mode or is in a cool-down cycle, also known as the "FireOff" phase.
- **Limit (Hopper Lid Switch):** This should be shaded when the hopper fill lid is closed. If this bubble is not shaded, the auger will be prevented from feeding any pellets.
- **Vacuum (Vacuum Pressure Switch):** This will be shaded when the stove's main chamber is under negative pressure, typically when the exhaust fan is running, and the door and ash pan are closed.
- **POF (Proof of Fire Sensor):** This shading indicates that the stove's exhaust housing has reached the thermal threshold to switch to the Heating phase of operation.
- **RT (Room Temp Sensor):** Displays the current temperature of the room near the stove.
- **HT (Hopper Temp Sensor):** Displays the current temperature of the hopper near the auger system.

Pressing the Information button a second time will access the Stove information screen.

- This screen will display information such as: Total ignite times, total running time, and program and power information.

The correct information for this stove is the following:

- Model: HP42_U01
- Voltage: ~115V
- Frequency: 60Hz

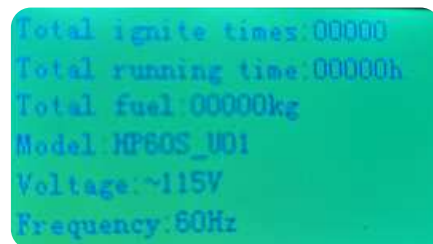

MAINTENANCE

Introduction to Maintenance

Regular maintenance and cleaning play a crucial role in ensuring the proper functioning of pellet stoves and extending the lifespan of their components. Many issues encountered with pellet stoves are directly related to a lack of maintenance. By regularly cleaning your stove, you can help it operate at its best. It's important to note that the frequency of cleaning may vary depending on the quality of fuel used. However, a clean stove generally burns fuel more efficiently. Therefore, prioritizing the cleanliness of your stove is key to its optimal performance.

Soot and Fly Ash - Formation and need for Removal:

- The products of combustion will contain small particles of fly ash.
- Fly ash will collect in the exhaust venting system and restrict the flow of the flue gasses.
- Incomplete combustion, such as occurs during startup and shutdown, or incorrect operation of the room heater will lead to some soot formation which will collect in the exhaust venting system.
- The exhaust venting system should be inspected at least once every year to determine if cleaning is necessary.

Importance of regular cleaning and maintenance:

- Regular cleaning of your pellet stove helps to remove any accumulated ash, dust, and debris that can hinder its performance. Over time, these deposits can restrict airflow, reduce heat output, and lead to inefficient combustion. By keeping the stove clean, you can maintain its efficiency, heat output, and overall effectiveness.
- Additionally, routine maintenance allows you to inspect and address any potential issues before they escalate. It helps identify and resolve minor problems, such as loose electrical connections, worn-out components, or clogged venting, preventing them from developing into more significant issues. Regular maintenance ensures that the stove operates smoothly, minimizing the risk of breakdowns and extending its lifespan.

Ensuring optimal performance and longevity:

- Proper cleaning and maintenance play a crucial role in maximizing the performance and longevity of your pellet stove. When the stove is clean and well-maintained, it operates at its designed efficiency, providing consistent and efficient heat output. This not only enhances your comfort but also contributes to energy savings and cost-effectiveness.
- Regular maintenance helps identify and address any potential safety hazards, reducing the risk of fire, carbon monoxide leaks, or other safety-related issues.

⚠️ WARNING!

- Never perform cleaning or maintenance on a hot stove.
- Allow unit to cool completely.
- Interior components may still be hot, even when stove surfaces are cool to the touch. A protective glove is recommended.
- Clinkers may remain hot for several minutes after they are pulled from the burn pot.
- Never perform service with power supplied to the unit.

Side Panel Access

In order to effectively clean and maintain various areas of the stove, it is necessary to access the internal components.

- Locate and loosen the 4mm Allen screws, located on the fold-over lip at the rear of each side panel.
- Once the 4mm screws are loosened, the panel can be slid toward the rear of the stove and pulled off.
- Refer to the HP54 section of the following Side Panel Access Video as it is very similar.



MAINTENANCE

Exterior Cleaning & Maintenance

- **Wiping down the exterior surfaces:**
 - Begin by using a soft, lint-free cloth to gently wipe down the exterior surfaces of the stove. This removes any loose dirt, dust, or debris that may have accumulated.
 - Take care to cover all areas, including the top, sides, front, and back of the stove.
 - Do not use any liquids or harsh chemicals or abrasive cleaners, as they can damage the finish.
- **Regular maintenance:**
 - To maintain the exterior cleanliness of your stove, it is advisable to incorporate regular dusting and wiping as part of your routine maintenance. This prevents the build-up of dirt and grime, making future cleaning easier and more efficient.

Heat Exchanger & Glass Cleaning

- **Heat Exchanger:**
 - Locate the pre-installed scraper unit at the top of the stove, specifically designed for cleaning the heat exchanger.
 - With the front door of the stove closed to contain the ash, pull the rod attached to the scraper unit in and out a few times. *(May be a hook or a knob)*
 - As you do so, the accumulated soot and ash will fall down to the burn pot and ash pan area.
 - Perform this cleaning task daily or as needed to maintain a clean heat exchanger and prevent the buildup of soot and ash.
 - Never touch the scraper rod while the stove is hot or running. Severe burns can occur.
- **Ceramic Glass Cleaning:**
 - Wait until the stove has completely cooled down before attempting to clean the glass.
 - Gently wipe the surface with a damp cloth, removing any soot, residue, or fingerprints.
 - For stubborn stains or build-up, use a ceramic glass cleaner specifically designed for stoves or fireplaces.
 - Once the ceramic glass is clean, wipe it dry with a clean, lint-free cloth to avoid streaks or water spots.



⚠ CAUTION!

- Do Not operate stove with broken glass
- Do Not slam door shut or strike glass.
- Do Not clean hot glass.
- Do Not use abrasive cleaners.
- Replace with factory authorized ceramic glass only.



Burn Pot & Ash Pan Cleaning

- **Burn Pot Cleaning:**

- Empty the contents of the burn pot into a metal container designated for ash disposal, or directly into the ash pan drawer to either side.
- Look for any accumulated ash, soot, or residue.
- Use a suitable tool such as a brush or scraper to remove any buildup.
- Ensure that all residues are thoroughly removed.
- Once cleaned, reposition the burn pot back into its original place within the stove.
- Take care to ensure that the front edge of the pot falls behind the rectangular catch at the front of the cradle, and that the burn pot sits completely flush.



- **Ash Pan Insert Cleaning:**

- Open the front door and remove the ash pan insert from the stove, taking caution as it may contain hot ashes or debris.
- Empty the ash pan contents into a designated metal container for ash disposal.
- Look for any accumulated ash, soot, or residue that may have fallen outside of the ash pan.
- Use a vacuum cleaner to remove any remaining ashes or debris from this area.
- Once cleaned, reposition the ash pan drawer back into its original place within the stove.

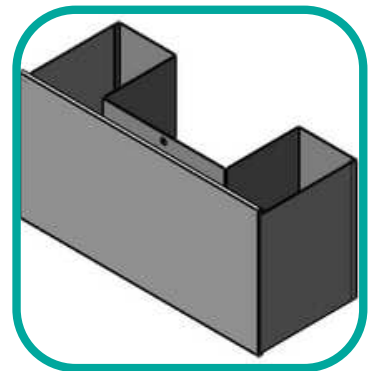

Note on Proper disposal of ashes:

- *Always dispose of ashes in a designated metal container specifically intended for ash disposal.*
- *Allow the ashes to cool completely before disposal to prevent any fire hazards.*
- *Do not dispose of ashes in combustible containers or near flammable materials.*
- *Store the ash container in a safe place away from any potential fire risks until the ashes have cooled completely.*
- *Once cooled, you can safely dispose of the ashes according to local regulations or guidelines.*

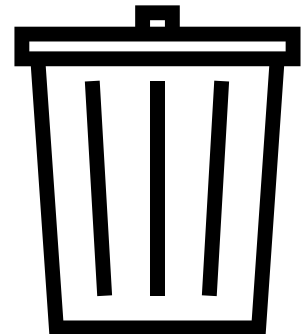

Interior Chamber Cleaning

- **Interior Cleaning:**

- Use a vacuum cleaner with a narrow nozzle or a brush attachment to carefully clean the cradle area underneath the burn pot.
- Additionally, use the vacuum to clean out the igniter tube, removing any dust or debris that may have accumulated.

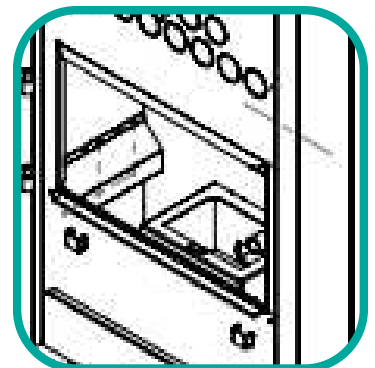



Hopper Cleaning and Auger Maintenance

To ensure optimal performance and prevent issues related to pellet dust, regular maintenance of the hopper and auger is essential. Follow these steps to maintain the hopper and lubricate the auger:

- **Foreign Debris:**
 - Regularly check and screen the pellets to remove any dust or potential foreign objects from the hopper, ensuring uninterrupted operation.
- **Pellets Bridging:**
 - Bridging of pellets can occur due to various factors such as the roughness and shallow slope of the hopper's metal surface, humidity levels, static electricity, and pellet dustiness.
 - Apply a smoothing agent to the hopper metals to create a slick surface and minimize pellet bridging.
 - Keep the hopper area clean and free from excess dust to ensure a smooth and consistent feed for the auger.
- **Auger Lubrication Maintenance:**
 - Perform auger lubrication maintenance at least once per heating season.
 - Depending on pellet quality and usage, more frequent lubrication may be necessary, ranging from monthly to as needed.
 - Coat the hopper metals with a smoothing agent to reduce the likelihood of pellet dust affecting the auger bearing plate.
 - Regularly monitor and maintain the hopper condition to ensure optimal pellet flow.
- **Emptying and Vacuuming the Hopper:**
 - Before maintenance, ensure that the hopper is empty of any remaining pellets.
 - Use a vacuum cleaner with a narrow attachment to thoroughly clean out the hopper, removing pellet dust or debris that may have accumulated.
- **Applying Nonflammable Lubricant:**
 - Activate the auger by putting the stove in diagnosis mode or auger priming (refer to page 32 for instructions).
 - Apply a small amount of nonflammable lubricant at the bottom of the auger plate, allowing it to penetrate the bearing housing.
 - Synthetic PTFE-based lubricants are recommended for their effectiveness and long-lasting results.
- **Wiping Up Residue and Allowing Dissipation:**
 - After applying the lubricant, carefully wipe up any excess pooling or residue around the auger area.
 - Allow sufficient time for all vapors from the lubricant to dissipate completely before proceeding.

By following these maintenance steps, you can ensure the cleanliness and efficient operation of the hopper and auger system, minimizing pellet bridging and maximizing the performance of your stove.





Rear Combustion Chambers Cleaning and Maintenance

Proper maintenance of the rear exhaust chambers is crucial for optimal performance and should be performed every ton (50 bags) of pellets burned or as needed, based on pellet quality.

To ensure the cleanliness and efficiency of the rear exhaust chambers, it is important to follow these steps:

- **Locate the Chamber Cover Plates:**
 - Find the small rectangular metal plates affixed with Allen screws.
 - There are four chamber cover plates in total, two on each side of the stove behind the side panels.
 - These plates are located on the left and right sides of the burn chamber.
- **Remove the Chamber Cover Plates:**
 - Unscrew the Allen screws to detach the cover plates.
 - Gently pull the plates back, noting the presence of a gasket behind them.
 - If necessary, it is acceptable to cut through the center of the gasket to access the chamber, as long as there is adequate gasket material remaining around the perimeter to ensure a proper seal.
- **Thoroughly Vacuum the Chambers:**
 - Use an ash vacuum with a slender hose attachment to vacuum the chambers from top to bottom.
 - The chambers extend up to the heat exchange tubes near the top of the stove, so it is essential to clean the entire chamber.
 - Employ a sweeping motion with a slender, flexible brush, on the top cleanouts, preferably a 1" - 1½" diameter coil brush, to ensure comprehensive cleaning.
 - This brushing motion helps remove ash and soot, leaving no area neglected.
- **Gasket Replacement:**
 - If the gaskets are damaged or showing signs of wear, they should be replaced.
 - Purchase replacement gaskets that are designed for heat level of your stove model.
 - Remove the old gaskets from the chamber cover plates. Ensure that any remaining gasket material is thoroughly cleaned from the plates.
 - Place the new gaskets on the chamber cover plates, ensuring they are properly aligned.
 - Reattach the chamber cover plates, securing them with the wing nuts or Allen screws.
 - Verify that the new gaskets create an airtight seal when the chamber cover plates are in place.

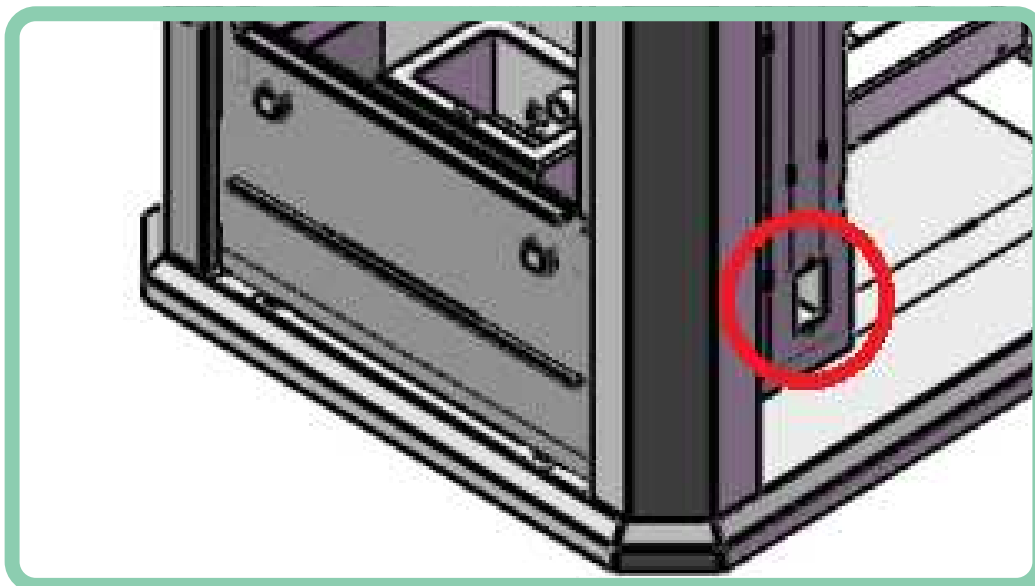



Exhaust Housing & Venting Cleaning and Maintenance

Proper maintenance of the exhaust venting, combustion blower housing, and impellers is essential for the efficient operation of your pellet stove. Follow these guidelines to inspect and clean these components:

- **Exhaust Venting Inspection and Cleaning:**

- Annually, or as needed, it is crucial to inspect the exhaust venting system of your pellet stove to ensure it is free from any obstructions or damage that could hinder proper exhaust flow.
- Start by visually examining the entire length of the venting system, including the tee cleanouts and elbows. Look for signs of blockages, such as bird nests, debris buildup, or excessive creosote.
- If you notice any visible obstructions, carefully remove them using appropriate tools. Be cautious not to damage the venting pipes or components during the process.
- To thoroughly clean the venting system, you can use a specialized vent brush or a flexible rod designed for pellet stove vent cleaning. Insert the brush or rod into the venting pipe and gently scrub the interior surfaces to dislodge any accumulated soot, ash, or debris.
- As you clean, pay close attention to the areas where the venting pipes connect to elbows, cleanouts, or other components. Ensure that the connections are tight and properly sealed with gaskets or high-temperature silicone to prevent any leaks.
- Check the condition of the gaskets or seals at the connection points. If you notice any signs of wear, cracking, or deterioration, it is advisable to replace them with new gaskets to maintain an airtight seal.
- Additionally, inspect the exterior of the venting system for any signs of damage, such as dents or corrosion. If any significant damage is present, it is recommended to consult a professional technician for further evaluation and repair.

- **Combustion Blower Housing and Impellers Inspection and Cleaning:**

- Annually, or as needed, inspect the combustion blower housing and impellers for any buildup of dust, debris, or residue.
- Remove the combustion motor from the housing, following the manufacturer's instructions, to access the impellers and interior components.
- Thoroughly clean the housing, impellers, and surrounding areas using a soft brush, compressed air, or a vacuum cleaner.
- Inspect the combustion motor gasket for any damage. If the gasket is compromised, replace it with a new blower flange gasket between the blower flange and the steel plate.
- During reassembly, ensure not to over-tighten the wingnuts to prevent damage.

Regular inspection and cleaning of the exhaust venting, combustion blower housing, and impellers help maintain proper airflow, prevent blockages, and ensure the efficient operation of your pellet stove. If you notice any significant damage or issues, it is advisable to consult a qualified technician for further assistance.





Annual Professional Service

- It is highly recommended to schedule an annual professional service for your pellet stove to ensure its optimal performance, safety, and longevity.
 - Engaging a qualified technician for thorough maintenance ensures that your stove operates efficiently and reduces the risk of potential issues.
- An annual professional service typically involves a comprehensive inspection and cleaning of various components, including those that may be difficult for homeowners to access or maintain.
- During the annual service, the technician will conduct a thorough examination of the stove's internal and external components, electrical connections, and safety features.
 - They will also inspect and clean critical parts such as the burn pot, heat exchanger, auger system, combustion fan, and exhaust venting system.
 - The technician will check the condition of seals, gaskets, and other vital components, replacing them as necessary to maintain proper operation and safety standards.
 - Additionally, they will verify the calibration and functioning of safety switches, sensors, and control systems to ensure accurate operation and reliable performance.
- The technician may also perform any necessary adjustments, lubrication, or fine-tuning to optimize the stove's efficiency and combustion process.
- The annual professional service is also an opportune time for homeowners to address any concerns or questions they may have regarding their stove's operation, maintenance, or performance.
- By scheduling an annual professional service, you can have peace of mind knowing that your pellet stove has been thoroughly inspected, cleaned, and serviced by a trained technician, ensuring its safe and efficient operation throughout the year.

Remember to keep a record of the annual professional service, including the date, tasks performed, and any recommendations or maintenance tips provided by the technician. This documentation will serve as a reference and help you stay on top of the stove's maintenance schedule.

Maintenance Disclaimer

Please note that all of the required maintenance covered in this manual is the sole responsibility of the stove owner and is not covered under the manufacturer or any other warranty. It is important to understand and acknowledge the significance of assuming this responsibility to ensure the safe and efficient operation of your pellet stove. By taking proactive measures to perform regular cleaning and maintenance, you not only contribute to the longevity and optimal performance of your stove but also prioritize the safety of your household.

The manufacturer provides this comprehensive manual to guide you through the necessary maintenance tasks, offering step-by-step instructions and helpful tips. However, it is essential to emphasize that the responsibility for performing these maintenance activities lies with you as the stove owner. Neglecting or failing to carry out the recommended maintenance procedures may result in diminished performance, increased risk of malfunctions, and potential safety hazards.

While your stove may come with a warranty that covers certain manufacturing defects or malfunctions, it is important to note that routine maintenance, cleaning, and servicing fall outside the scope of warranty coverage. By assuming the responsibility for these maintenance tasks, you demonstrate your commitment to the long-term care and performance of your stove.



Introduction

- Welcome to the Troubleshooting section of this manual, designed to assist you in resolving common issues that may occur with your pellet stove. It is important to note that while this section provides a brief overview of solutions for some of the more common problems, it is not an exhaustive list. However, it serves as a starting point to help you identify and address issues effectively.
- On this first page, you will find a reference chart that outlines common problems along with QR codes linking to instructional videos for each specific problem. These videos offer visual guidance to supplement the troubleshooting process.
- As you delve further into this section, you will find detailed explanations and solutions for each problem covered in the reference chart. This expanded information provides a comprehensive understanding of the troubleshooting steps to follow, allowing you to tackle issues with confidence.
- Remember, safety is paramount. If you encounter a problem that requires expertise beyond the scope of this manual, or if you are unsure about any troubleshooting procedures, it is advisable to seek professional assistance. Additionally, keeping a record of your troubleshooting efforts can be helpful for future reference and maintenance.
- With the resources and information provided in this Troubleshooting section, you will be equipped to address common pellet stove issues, ensuring optimal performance and a comfortable living environment. Let's begin exploring the troubleshooting process and empowering you to overcome any challenges you may encounter.

- Fault codes and error messages can be cleared off of the main screen by **pressing and holding the On/Off  button for 5 seconds.**

(This acknowledges the error, and allows the stove to be restarted)

Lack of Power At Panel:



Low Temperature Alert:



High Temperature Alert:



Ignition Failure Alert:



Lazy Flame-Pellet Buildup



Auger Issues





Problem/Solution Reference

Problem: Lack of Power at the Control Panel

If you are experiencing a total loss of power at the control panel, it indicates an interruption in the flow of electricity. Understanding the path of electricity can help diagnose and resolve the issue:

- **Flow of Electricity:** The flow of electricity follows the following path: Main power cord > rear switch block > wiring harness > main circuit board > data cable > control panel.

Solutions:

- **Check the Electrical Outlet:** Ensure that the electrical outlet where the stove is plugged in is functioning properly.
- **Verify Power Switch Position:** Check the position of the power switch on the stove. Make sure it is set to the "On" position. The "On" position is typically indicated by "--" while the "Off" position is represented by "0".
- **Inspect Wires and Connections:** Examine all wires and connections associated with the power switch, main circuit board, and control panel. Ensure they are securely connected and free from any damage or loose connections.
- **Check the Fuse:** Locate the fuse at the back of the main power switch block. The fuse is typically housed in a pull-out tray. There may be both an active fuse and a backup fuse. The active fuse is usually found in the saddle, while the backup fuse is placed in a plastic sleeve.



Problem: Failure to Ignite or "Too Much Smoke" Alert Message

The stove giving a failure to ignite message, means that either a fire failed to ignite, or that not enough heat was generated at the Proof of Fire sensor to engage the stove's Heating mode.

Solutions:

- **Check Igniter Functionality:** Ensure that the igniter is positioned correctly and getting hot inside its core within 2 minutes. Refer to the igniter troubleshooting video provided for guidance. If the igniter fails to heat up or shows signs of damage, it may need to be replaced to ensure proper ignition.
- **Verify Burn Pot Placement:** Confirm that the burn pot is properly seated and oriented correctly, with the small hole and ring positioned toward the back of the stove. Incorrect placement can hinder the ignition process and lead to a failure to ignite.
- **Ensure Adequate Pellet Feed:** Check if pellets are feeding and being delivered to the burn pot as intended. Refer to the feeder troubleshooting video for guidance. Observe the pellet delivery mechanism and ensure it is operating smoothly without any blockages or malfunctions. Insufficient pellet delivery can result in failed ignitions.
- **Ensure Proper Sealing:** Verify that the front door is tightly sealed to prevent air leakage. Inadequate sealing can disrupt the combustion process and lead to the accumulation of smoke or the failure to establish a consistent flame.
- **Check Combustion Fan and Airflow:** Confirm that the combustion fan is engaging and generating sufficient airflow through the stove via the air intake pipe. Proper airflow is crucial for supporting combustion and maintaining a stable flame. If the combustion fan is not functioning or airflow is restricted, it can result in ignition failures or excessive smoke production.
- **Proof of Fire Sensor:** If the fire successfully ignites within five minutes and maintains a steady flame but the stove fails to switch to Heating mode, it may indicate that the proof of fire sensor is not reading the temperature correctly. Press the info button (!) to pull up the status page. Next to POF, the temperature should steadily rise throughout the ignition process. If this sensor shows an error in the readout, or is not increasing with the fire, check the exhaust housing to ensure that the sensor did not come dislodged from the housing.



Problem: Low Temperature Alert Message

If you receive a low temperature alarm, it indicates that the stove's computer has lost communication with the proof of fire switch (POF). This alarm is typically triggered when the fire diminishes to a small size or embers. Several factors can contribute to this issue, with feeder interruptions being the most common cause. Feeder interruptions often occur due to low pellet levels in the hopper or leaving the hopper lid open for an extended period during refueling.

Solutions:

- **Check Pellet Level and Flow:** Ensure that the hopper contains an adequate amount of pellets. Insufficient pellets can lead to low density and inconsistent feeding. Check for any pellet bridging or funneling at the auger mouth opening, as these issues can affect the pellet flow. Clear any obstructions or adjust the pellet level as necessary to ensure a smooth and consistent feed.
- **Adjust Ash Cleaning Cycle:** Review the Ash Cleaning Cycle settings menu. If the low temperature alarm persists, consider shortening the cycle duration on the lower settings. Adjusting the Ash Cleaning Cycle can help maintain a sufficient fire and prevent temperature drops that trigger the alarm.
- **Verify Safety Switches:** Ensure that safety switches (Vacuum and Limit) are engaged during stove operation. For instance, if the hopper lid is left open, the auger will not feed, resulting in the low temperature alert.
- Ensure that the Proof of Fire sensor wire is still securely fastened into the exhaust housing.

Problem: High Temperature Alert Message

When your stove triggers a high temperature or overheat alarm, it indicates a potential issue with the stove's ability to dissipate heat effectively. Several factors can contribute to this alarm, including inadequate airflow, limited combustion airflow, incorrect fuel-to-air ratio settings, or a stove installation that exceeds the EVL recommendations.

Solutions:

- **Check Room Blower Functionality:** Ensure that the room blower fan is operating properly and effectively moving hot air out of the stove. Verify that the blower voltages are appropriately set to ensure sufficient airflow. If the blower fan is not spinning, attempt to manually flick it to check for any resistance or obstructions. If necessary, clean or repair the blower fan to restore proper functionality.
- **Clear Airflow Pathways:** Inspect and ensure that the airflow pathways within the stove are clear and unobstructed. Refer to the Maintenance & Cleaning section of the manual for guidance on cleaning air passages, vents, and other components that may impede airflow. Removing any blockages or buildup will help facilitate proper heat dissipation and prevent excessive temperatures.
- **Verify Exhaust Fan Performance:** Check the exhaust fan to ensure it is not obstructed and is functioning correctly. Make sure the fan is properly exhausting the combustion byproducts and hot air from the stove. Any obstructions or malfunctions in the exhaust fan can contribute to elevated temperatures within the stove.
- **Evaluate Temperature Sensor Placement:** If the stove is operating in Temperature mode, ensure that the room temperature sensor is not located in a cold spot. Placing the sensor in a colder area may cause the stove to run at higher levels than necessary, potentially leading to overheating. Adjust the sensor placement if needed to ensure accurate temperature readings.





Problem: Lazy or Dirty Flame / Buildup of Pellets in the Pot / Dark Black Smoke or Ash

If you observe a lazy or dirty flame, notice a buildup of pellets in the burn pot, or see dark black smoke or ash in the main chamber or at the end of the exhaust, these are abnormal occurrences that typically indicate a reduction in airflow.

Solutions:

- **Check Burn Pot Condition:** Inspect the burn pot for clinkers or blockages that may impede proper combustion. Ensure that the burn pot is securely seated flush on the cradle. Any gaps between the cradle and burn pot can allow air to bypass the pellets rather than passing through them, resulting in inefficient burning. Remove any obstructions and clean the burn pot thoroughly.
- **Verify Seals and Gaskets:** Examine the stove for any leakages or loose seals/gaskets, particularly around the glass door or ash pan. A compromised seal can disrupt the combustion process and lead to the accumulation of soot and smoke. Ensure that the side latches of the ash pan are securely fastened with even pressure.
- **Check Exhaust System for Blockages:** Inspect the exhaust chambers and venting for potential blockages. Over time, the accumulation of ash, soot, or debris can hinder proper airflow and cause incomplete combustion. Refer to the Maintenance and Cleaning section for instructions on how to clean and maintain the exhaust system effectively.
- **Ensure Proper Intake Airflow:** Verify that the intake air pipe is not plugged or blocked. Bugs and pests can sometimes make nests within these outside intake pipes.



Problem: Temperature Getting Too Warm in the Space

If the temperature in the room is rising beyond desired levels, it indicates that the stove is generating more heat than the space can dissipate over time. This situation commonly occurs during mild temperatures or in transitio

Solutions:

- **Turn Off the Stove:** To allow the space to cool down, turn off the stove completely. This will halt the heat generation and gradually restore a comfortable temperature.
- **Adjust Temperature Setting (*Temp Mode*):** Lower the temperature setting on the stove (in *Temp Mode*) to achieve the smallest fire possible. By reducing the heat output, the stove will generate less warmth, helping to maintain a more moderate room temperature.
- **Reduce Heat Level (*Manual Mode*):** In *Manual Mode*, set the stove to a lower heat level to minimize the fire's intensity. This adjustment will result in a reduced heat output, preventing excessive warming of the space.
- **Activate ECO Mode:** If even the lowest temperature setting or heat level is still causing the room to overheat, consider activating the ECO option (refer to the Operation > Set ECO section in the manual). ECO Mode allows the stove to automatically cycle on and off based on room temperature data, helping to regulate and maintain a more suitable temperature range. However, be aware that activating ECO Mode may increase the frequency of electronic igniter usage, leading to faster wear and higher electricity consumption.
- **Install a Wired Remote Thermostat:** An alternative solution is to install a simple wired remote thermostat. This enables more precise temperature control, ensuring that the stove operates within the desired temperature range. By accurately monitoring the room temperature, the remote thermostat can help prevent excessive heating.



Problem: Not Feeding Pellets or Auger noises (groans/squeals)

If the stove is operating but not feeding pellets, it indicates a problem with the auger system.

Solutions:

- **Check Hopper Fill Level:** Ensure that the hopper is adequately filled with pellets. Low pellet levels can lead to issues such as pellet bridging or funneling, resulting in low-density feeding problems. Maintaining a sufficient pellet supply in the hopper is crucial for proper auger operation.
- **Verify Switch Engagement:** Confirm that the hopper lid switch and vacuum pressure switches are engaging correctly. Press the information button (!) on the control panel to check if the Feed, Vacuum, and Limit indicators are engaging. Proper switch engagement ensures the necessary signals for auger operation.
- **Inspect for Auger Buildup or Jam:** Examine the auger system for any potential buildup or obstructions. Empty the hopper and attempt to activate the auger in the diagnosis menu to see if it turns freely. This will help identify any blockages or jams that might be hindering the smooth operation of the auger.
- **Lubricate the Auger System:** If the auger is producing squeaking or groaning noises, it may benefit from lubrication. Use a non-flammable synthetic PTFE oil or spray to lubricate the auger system. Proper lubrication can alleviate friction and ensure smooth movement of the auger. Refer to the Maintenance section for detailed instructions on lubricating the auger system.

Note: Humming sounds coming from the auger are normal, and not a cause for alarm, but if you are experiencing rhythmic groans or squeals, it indicates that dust has worked its way down into the bearing housing and needs to be displaced.

Problem: Alarm - Lost Connect

When the stove displays a Lost Connect alert, it indicates that the control panel is receiving power from the circuit board but is unable to establish communication with it.

Solutions:

- **Check Data Cable Connections:** Ensure that the 4-pin data cable is securely connected to both the back of the control panel and the bottom circuit board. Verify that the connection is snug and free from any looseness or disconnection.
- **Verify Cable Integrity:** Inspect the 4-pin data cable and its white plastic connector for any signs of loose or damaged wires. Make sure that all the wires are securely connected to the connector without any looseness or intermittent contact.
- **Verify Correct Pinout:** Confirm that the data cable is correctly pinned out on both ends. Check that the Transmit line (TX) and Receive line (RX) are correctly aligned and have not been swapped or pinned out incorrectly. Ensure that the pinout configuration is consistent on both the control panel and the circuit board.



Problem: ERR - Incorrect Room Temperature Reading

When the stove displays ERR instead of the expected room temperature, it indicates a problem with the accuracy of the temperature data received by the control panel from the room temperature thermocouple sensor.

Solutions:

- **Check Room Temperature Sensor Wire:** Inspect the room temperature sensor wire located behind the stove to ensure it is not crushed, cut, or damaged in any way. Any physical damage to the wire can affect the accurate measurement of the room temperature.
- **Verify Secure Connection:** Ensure that the room temperature sensor wire is securely connected to the white jumper connection on the circuit board. Refer to the wiring diagram provided by the manufacturer for the correct connection location. Confirm that the wire is firmly attached and making proper contact with the connection point.



Note: It is important to remember that even with the ERR display, the stove will continue to operate correctly when set to the Manual operational mode.



Warranty Coverage & Limitations

SMG Hearth & Home LLC - Comfortbilt Limited Warranty

SMG Hearth & Home LLC (SMG), on behalf of its Comfortbilt brand, extends the following warranty for Comfortbilt stoves purchased from an authorized retailer.

Warranty Coverage

Subject to the table below, SMG warrants to the owner of the Comfortbilt stove that the stove will be free from defects in materials and workmanship at the time of manufacture. After installation, if covered components are found to be defective in materials or workmanship during the applicable warranty period, SMG will replace the covered components.

SMG, at its own discretion, may fully discharge all of its obligations under such warranties by replacing the product itself or refunding the verified purchase price of the product itself. The maximum amount recoverable under this warranty is limited to the purchase price of the product. This warranty is subject to conditions, exclusions, and limitations as described below.

Warranty Period

Warranty coverage officially starts from the date of the original purchase. However, to account for shipping and delivery time, a small grace period of 30 days is provided before the warranty coverage begins.

- The warranty period for covered components is as follows:

Component Covered	Warranty Period
Electrical Components and Burn pot	1 Year
Steel Chassis Burn Chamber Parts (excluding burn pot)	3 Years
All purchased replacement parts come with a 90-day guarantee. <i>*Additionally, these replacement parts remain covered under either the remaining duration of the manufacturer's warranty or the extended parts warranty, whichever period is longer.</i>	90 Days
Glass	30 Days

Warranty Exclusions

Warranty does not cover damage or breakage due to misuse, improper handling, or modifications. There is no warranty on the paint, or any gaskets, or against damage caused from corrosion. There is no expressed or implied performance warranty on Comfortbilt stoves as SMG has no control over the installation, operation, cleaning, maintenance, or type of fuel burned.

SMG Hearth and Home LLC assumes no responsibility for, nor does the warranty extend to, smoke damage caused by reverse drafting of pellet appliances under shut-down or power failure conditions.

Some states do not allow exclusion or limitation of incidental or consequential damages, or limitations of implied warranties, so the limitations or exclusions set forth in this limited warranty may not apply to you. This limited warranty gives you specific legal rights and you may have other rights which vary from state to state. Warranty is void if the Comfortbilt stove has not been installed, operated, cleaned and maintained in strict accordance with SMG's instructions.

Neither SMG nor the Retailer from who you purchased your Comfortbilt stove shall be responsible, legally or otherwise, for the incidental, or consequential damage to property or persons resulting from the use of this product. Any warranty implied by law, including but not limited to implied warranties of the merchantability or fitness, shall be limited to One (1) year on the breach of this warranty or any type of warranty expressed or implied by law. SMG shall in no event be liable for any special, indirect, consequential, or other damages of any nature whatsoever in excess of the original purchase price of this product. All warranties by SMG are set forth herein and no claim shall be made against SMG on any oral warranty or representation.



Customer Support Options

Phone Support

For your convenience, we offer phone support to assist you with any questions, technical issues, warranty claims, or general inquiries you may have. Our dedicated support team is available to provide prompt assistance and guide you through troubleshooting steps or provide solutions to your concerns. Here are the different options available when contacting us through phone support:

- **Sales (Option 1):** If you have questions about purchasing a stove, pricing, or product availability, selecting Option 1 will connect you with our knowledgeable sales representatives who can provide detailed information and assist you in making the right decision for your needs.
- **Logistics (Option 2):** Should you have inquiries regarding shipping, delivery, or tracking your order, choosing Option 2 will connect you with our logistics team. They will be happy to provide updates on your shipment and address any logistical queries you may have.
- **Technical Support (Option 3):** Option 3 connects you to our technical support specialists who have expertise in troubleshooting and resolving technical issues related to your stove. They can assist you in diagnosing problems, offering step-by-step guidance, and ensuring the optimal performance of your stove.

Please dial our phone support number, **919-973-4079**, and select the appropriate option that corresponds to your inquiry.

Online Support

We understand that some situations may be better addressed through digital channels. That's why we offer online support options to ensure quick and efficient assistance. Here are the online support channels available:

- **Online Live Chat:** Through our official websites, www.comfortbilt.net, and www.comfortbilt.ca you can access our online live chat feature. This allows you to engage in real-time conversations with our support representatives. Simply click on the live chat icon in the lower right-hand corner on our website to initiate a chat session and receive immediate assistance.
- **Email Ticketing (Best option for Warranty Claims):** For inquiries that require detailed explanations or if you prefer written communication, our email ticketing system is available. By visiting the Tech Support page, or following the QR code link below, you can submit a support ticket with your query, and our team will respond to you promptly via email. This method allows for thorough documentation and tracking of your inquiries.

Additionally, we provide a dealer locator map on our website: <https://comfortbilt.net/pages/dealer-locator>. This feature enables you to find local dealers near your area, making it convenient for you to access in-person support or explore options for purchasing, servicing, or maintaining your stove.

Online Live Chat

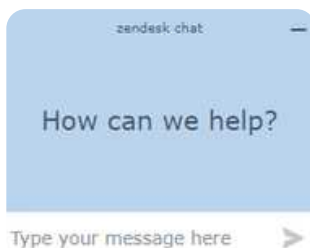

Email Ticketing



Dealer Locator





Technical Specifications

Emissions Report No.	105433724MID-003
EPA Certified	1.07 grams / hr.
*HHV Tested Efficiency	86.1%
**BTU Output	14,857 - 42,370 BTU / hr.
***Heating Capacity	Up to 2,500 ft ²
Exhaust Port Size	75mm (3")
Air Intake Port Size	50mm (2")
Hopper Capacity	115 lbs (approximate)
Fuel	Premium Wood Pellets
Shipping Weight	275 lbs

*Weighted average HHV efficiency using data collected during EPA emissions test

**Maximum BTU output based on HHV efficiency and the high burn section of the EPA emissions test.

***Heating capacity depends on climate zone, structure layout, insulation ratings, and other factors.

Electrical Specifications:

- 115VAC, 60Hz, Start 4.01 Amps, Run 1.43 Amps
- **Room Blower:** 0.62 Amps
- **Combustion Blower:** 0.55 Amps
- **Auger Motor:** 0.26 Amps
- **Igniter:** 3.2 Amps

Any generator, UPS, or battery backup system must have a Pure Sine Wave power signature.

Glass Specifications:

- This stove is equipped with ceramic glass.
- Replace glass only with ceramic glass.
- Please contact Comfortbilt for replacement glass.

Size Specifications:

- **Height:** 40"
- **Width:** 24.75"
- **Depth:** 27"

*43" Height and 30.5" Depth with mounted control panel.

Size Specifications:

- **Exhaust:** 5.25" from centerline, 9" from floor.
- **Intake:** 4.25" from centerline, 6.5" from floor.

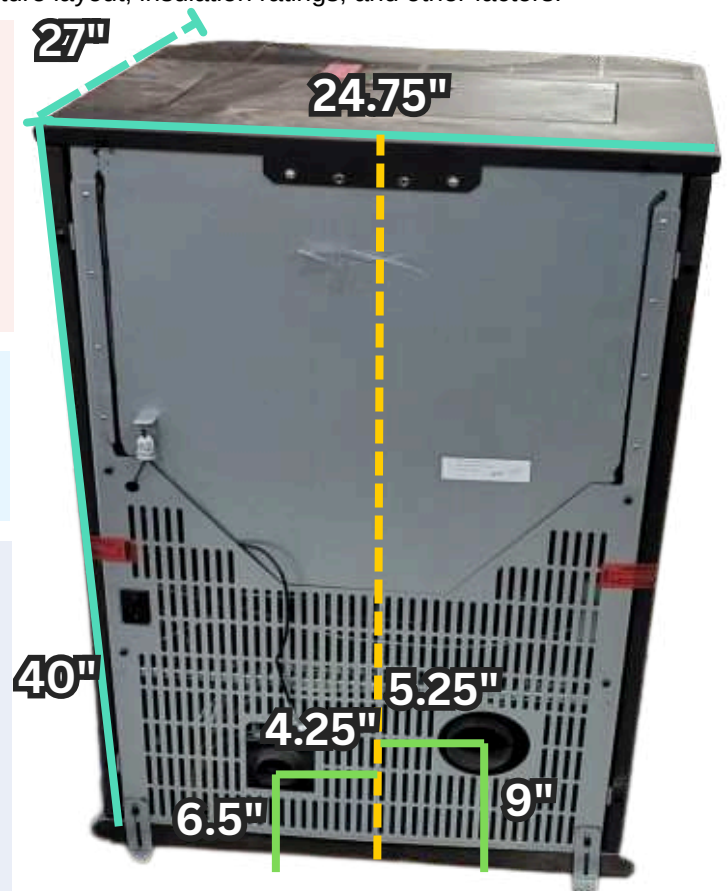

This manual describes the installation and operation of the Brand Comfortbilt, Model HP42 wood pellet stove. This stove meets the 2020 U.S. Environmental Protection Agency's pellet fuel emissions limits for wood stoves sold after May 15, 2020. Under specific conditions, this stove has been shown to deliver heat at rates ranging from 14,857 to 42,370 Btu/hr.

Complies with ASTM E1509, ULC S627, ASTM E2515, ASTM E2779, CSA B415.1

APPENDICES

Wiring Diagram

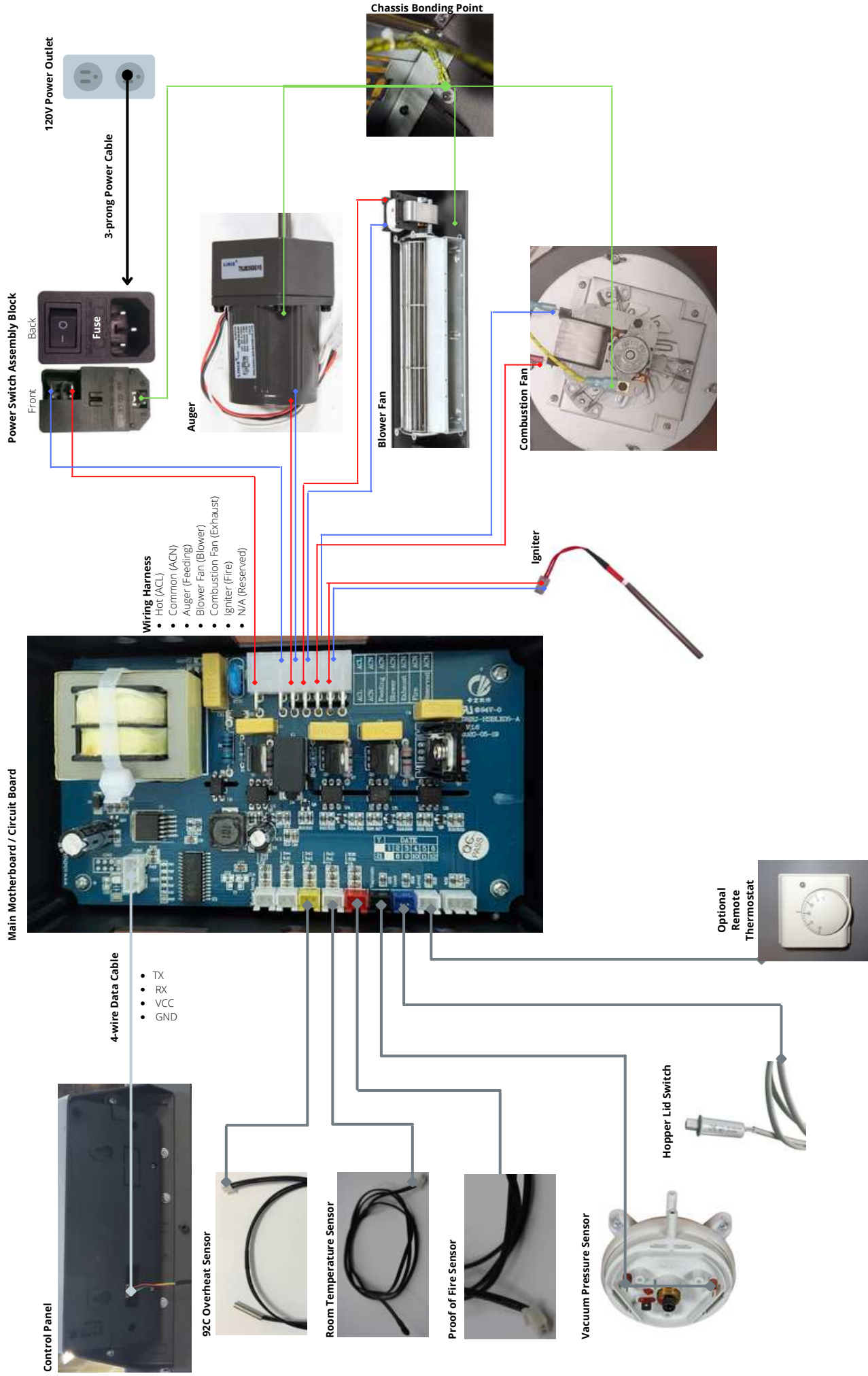

APPENDICES



Explosion View Description

NO.	DESCRIPTION	QTY		NO.	DESCRIPTION	QTY
1	FIREBOX WELDMENT	1		29	CIRCUIT BOARD COVER	1
2	EXHAUST ADAPTOR TUBE WELDMENT	1		30	CIRCUIT BOARD	1
3	ASH DRAWER INSERT	1		31	CIRCUIT BOARD BOX	1
4	BURN POT	1		32	FRONT DOOR WELDMENT	1
5	FIRE SHIELD SUPPORT	2		33	HANDLE ROLLER	1
6	FIRE SHIELD CENTER PLATE	2		34	HANDLE SHAFT	1
7	SUCTION STRUT	4		35	GLASS PRESSURE PLATE	1
8	FIRE SHIELD CENTER PLATE #2	1		36	GLASS	1
9	CENVECTION BLOWER BRACKET	2		37	GLASS PRESSURE PLATE BRACKET	2
10	CONVECTION BLOWER FAN	1		38	METAL HANDLE	1
11	EXHAUST FAN ASSEMBLY	1		39	WOOD HANDLE	1
12	AIR INTAKE TUBE WELDMENT	1		40	GLASS SEAL ROPE	1
13	AIR INTAKE DAMPER	1		41	BLOWER VENTS	1
14	AIR INTAKE PIPE SEAL PLATE	1		42	DECORATIVE ASSEMBLY	1
15	AIR INTAKE DAMPER ADJUSTMENT	1		43	BOTTOM TRIM	1
16	CLEANING CUTOOUT COVER	4		44	LEFT SIDE PANEL	1
17	ASH CLEANING ROD	1		45	RIGHT SIDE PANEL	1
18	VACUUM TUBE	1		46	TOP WELDMENT	1
19	HOPPER ASSEMBLY	1		47	HOPPER LID ASSEMBLY	1
20	AUGER HOUSING TUBE WELDMENT	1		48	HOPPER LID BUCKET HANDLE	1
21	BEARING 6902ZZ	1		49	CONTROLLER	1
22	AUGER	1		50	CONTROLLER BRACKET	1
23	BOTTOM BEARING RETAINER	1		51	POWER SWITCH	1
24	BEARING 61904DOU	1		52	BACK PLATE	1
25	BEARING CLIP	1		53	IGNITER	1
26	FEED MOTOR BRACKET	1		54	LEVELING FEET AJUSTMENT KIT	4
27	AUGER FEED MOTOR	1		55	ROOM SENSOR HOLDER	1
28	VACUUM SWITCH	1		56	BOTTOM TOP SHIELD	1

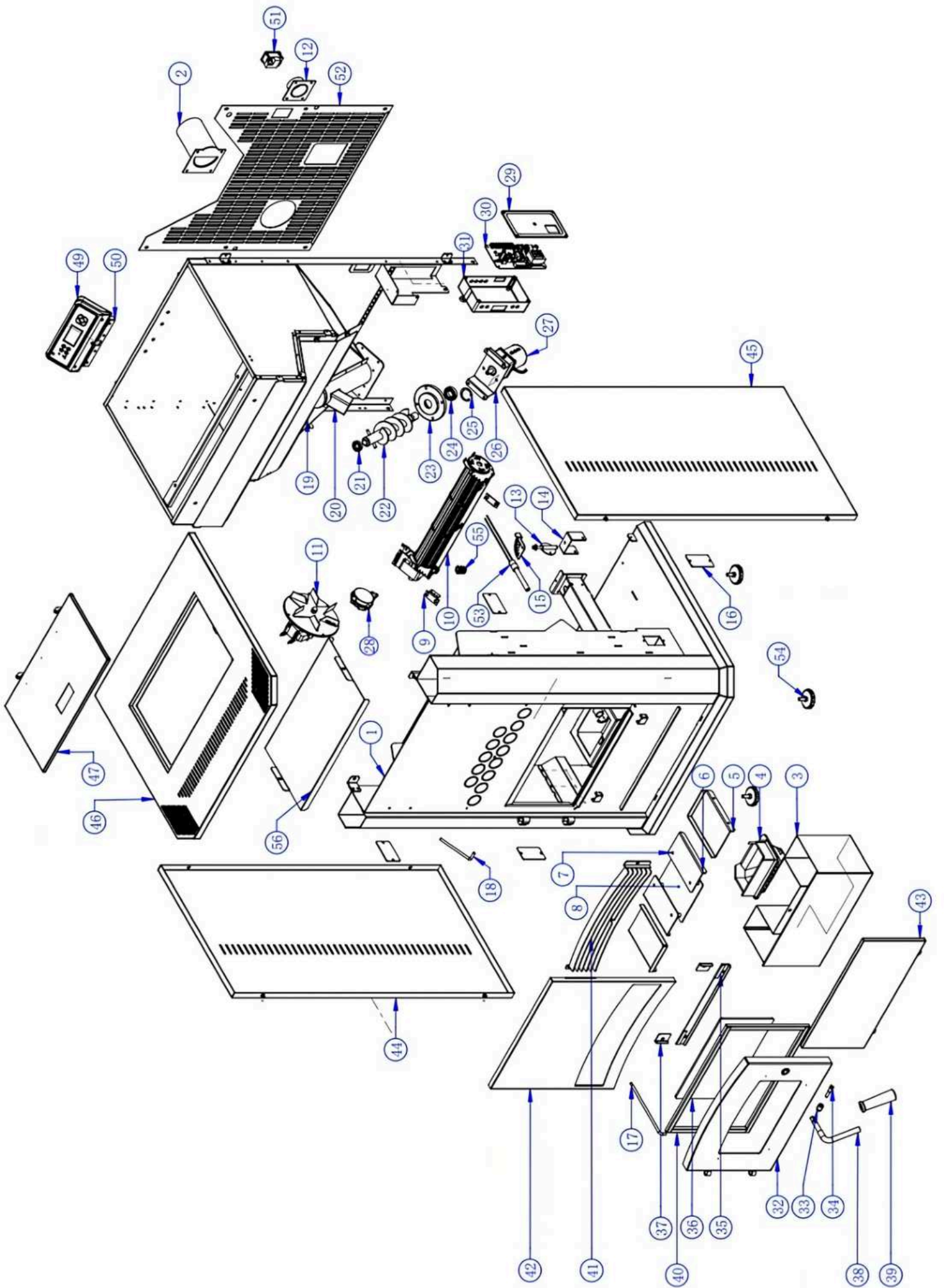



CONTACT US:

**3871 SOUTH ALSTON AVE.
DURHAM, NC 27713
919-973-4079**

For the most up to date information, visit:

WWW.COMFORTBILT.NET

OR

WWW.COMFORTBILT.CA